

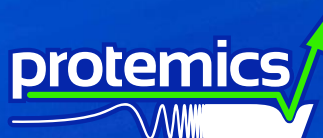

A NEW WAY TO SEE



Content

- [Application areas](#)
- [Scanner System: TeraCube](#)
- [Terahertz microprobe series](#)
- [TeraSpike transceivers](#) **new**
- [THz on-chip TDS devices](#) **new**
- [TeraSpike XR-option](#)
- [TeraSpike WT-option](#)
- [TeraSpike TD-1550-Y-BF](#)
- [THz Emitter: TeraBlast](#)
- [Frequency conversion: SHG-Unit](#)
- [THz Test Target: P-TTT-2-1200](#)
- [Low-noise amplifier: TeraSpike Companion](#) **new**
- [Sub-system modules](#)



Terahertz microprobe

Application areas

电话: 0755-84870203
 邮箱: sales@highlightoptics.com



Terahertz microprobing technology:

Taking advantage of Terahertz range benefits without being compromised by wavelength-based resolution limitations.

Terahertz Research	Thin-film Inspection	Chip-package Testing	Volume Screening
<p>Application areas:</p> <ul style="list-style-type: none"> • Metamaterials • Plasmonics • Passive devices • Emitters • Antennas • Waveguides • Sensor surfaces • Graphene 	<p>Application areas:</p> <ul style="list-style-type: none"> • Solar cells • Displays • Flexible electronics • Semiconductors • Graphene • Transparent conductors 	<p>Application areas:</p> <ul style="list-style-type: none"> • Time-domain reflectometry • Fault isolation • Packaging level inspection • 3D integration • Through silicon via (TSV) 	<p>Application areas:</p> <ul style="list-style-type: none"> • Laser plastic weld inspection • Fiber infomed polymers • Chip underfill inspection • Organic layer screening
<p>Benefits:</p> <ul style="list-style-type: none"> • Near-field access • Cost-efficient system extension • High-sensitivity • Low-invasiveness • Polarisation sensitive • Broadband 	<p>Benefits:</p> <ul style="list-style-type: none"> • Sheet resistance imaging • Contactless • Micron-scale resolution • Large-area scanning • High-speed scanning 	<p>Benefits:</p> <ul style="list-style-type: none"> • Market leading TDR resolution • Sub-ps rise-times • Contactless • Non-destructive • Cost advantage over all-electronic systems 	<p>Benefits:</p> <ul style="list-style-type: none"> • Non-destructive • Fast inspection • Screening of Vis/IR opaque plastics • Detection of micron-scale structures

Femtosecond-laser-based THz systems

Photoconductive TeraSpike microprobes are the key enabling components for high-resolution Terahertz imaging offering unprecedented sensitivity, resolution and non-invasiveness.

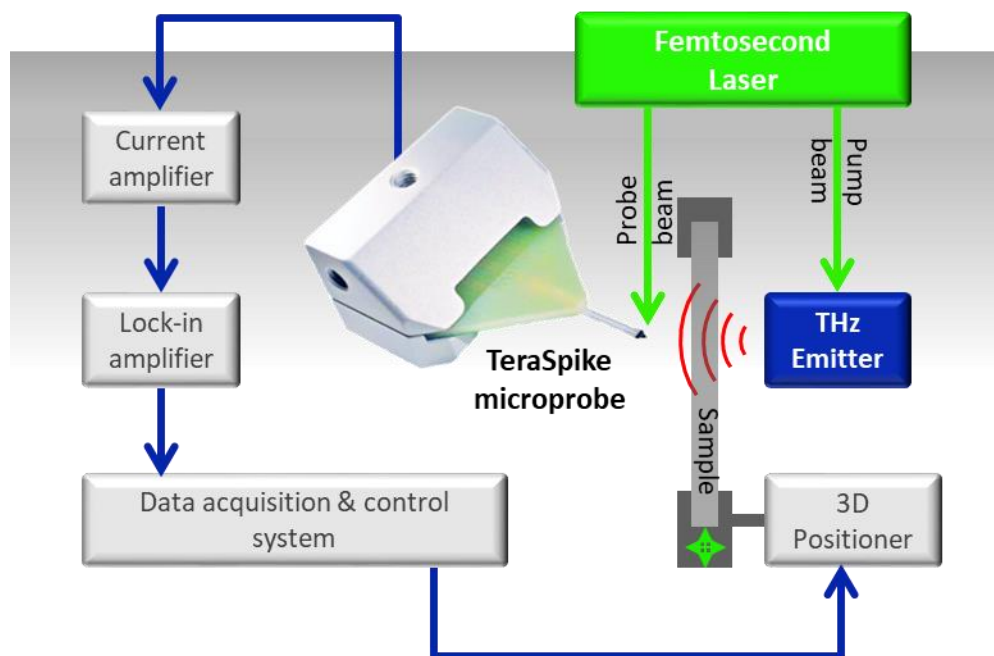

Simplified exemplary scheme of a TeraSpike-enabled THz near-field imaging system.

We offer

- **Systems:** Near-field imaging systems, sub-systems, modules & custom solutions
- **Components:** THz microprobes, THz emitters, accessories,...
- **Measurement services**

Please contact us for further information or inquiries.

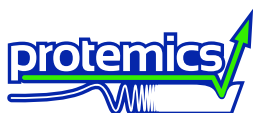

Protemics GmbH
Otto-Blumenthal-Str. 25
52074 Aachen
Germany

www.protemics.com
info@protemics.com
Phone: +49 241 8867 140
Fax: +49 241 8867 560

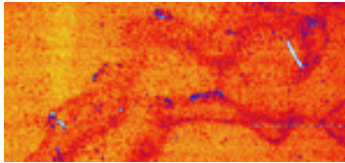

Thin-film Inspection

Application areas:

- Solar cells
- Graphene/ 2D-Mat.
- Displays
- Flexible electronics
- Semiconductors
- Transparent conductors

Benefits:

- Sheet resistance imaging
- Contactless
- Micron-scale resolution
- Large-area scanning
- High-speed scanning

Contact-free, high-resolution and high-speed sheet resistance & mobility imaging

Semiconductor wafer scanners with TeraSpike microprobes yield more information in a shorter time – compared to the prior art*.

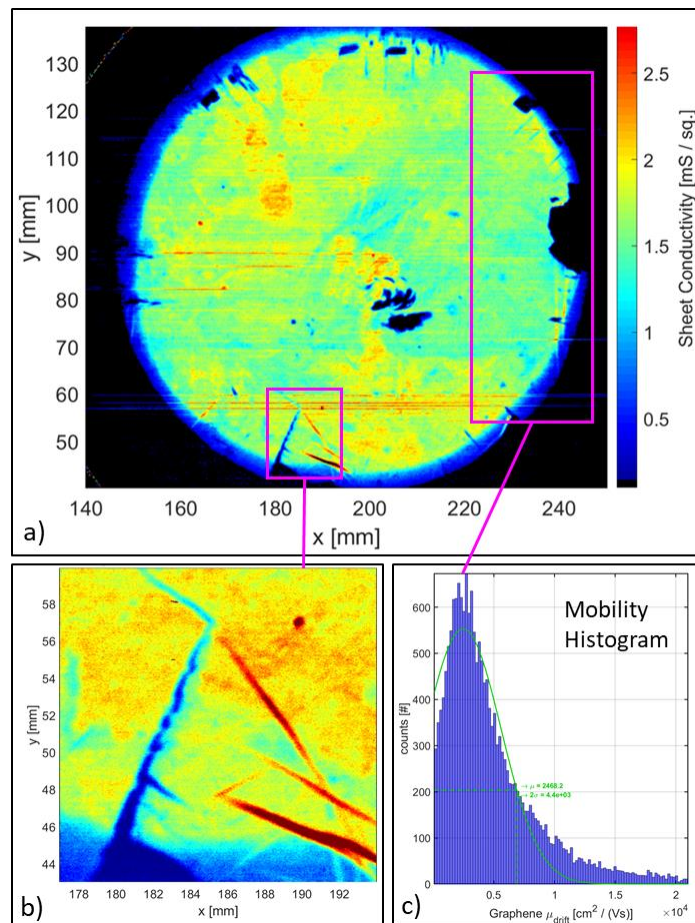

a) Results from a Terahertz near-field transmission measurement at a four-inch diameter graphene layer on silicon. b) High-resolution measurement within the marked area with visible defects from the graphene transfer process. c) Charge carrier mobility histogram for the marked region of the graphene layer.

* Such as Eddy-Current probe, or four point probe tools.

Thin-film inspection

Sheet resistance imaging

THz transmission working principle

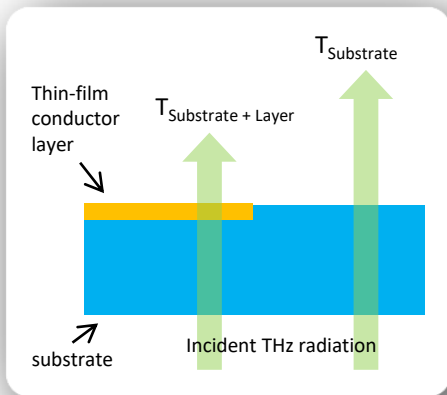

Tinkham formula:

$$T = \frac{T_{SL}}{T_S} = \frac{1}{1 + \frac{Z_0}{R_{sh} \cdot (n + 1)}}$$

M. Tinkham: *Phys. Rev.* vol. 104, pp. 845-846, 1956

Accessible measurement ranges and sample conditions

	Optimal	Acceptable	Difficult
Graphene R_{sh}	5 – 500 Ω/\square	0.5 – 5000 Ω/\square	< 0.1 Ω/\square > 10000 Ω/\square
Substrate Material	Sapphire Al_2O_3 , Crystalline Quartz SiO_2 , Highly resistive ($\rho > 100 \Omega cm$) semiconductors	Flexible Dielectrics, Lightly doped Semiconductors	Paper, Strongly Doped or metalized Substrates
Substrate Curvature and stiffness	Flat and rigid	Flexible and slightly bended	Strongly curved or 3-dimensional
Substrate Thickness variation	< 1 μm	< 20 μm	> 100 μm
Spatial Resolution	25 – 250 μm	10 – 10000 μm	< 5 μm
Sample Size (longer edge)	20 – 100 mm	5 – 150 mm	< 1 mm > 300 mm
Measurement Points	100 Px – 100 kPx	< 1 MPx	> 1 MPx

THz near-field scanning system

TeraCube Scientific

new



Key features

- High-speed continuous move scanning & data acquisition
- Optical sample topography detection for scanning at constant microprobe/surface-distance
- Synchronized motion-control and real-time position detection
- Linear polarized and rotatable THz emitter for polarization-dependent measurements
- High performance THz emitter/detector component
- High dynamic range Lock-in detection
- Integrated CCD camera module for monitoring of microprobe tip and sample position
- System control and measurement automation software on integrated PC unit
- Software-implemented alignment monitoring function and system health check electronics
- Software assisted microprobe-tip to sample surface approximation
- Time-domain signal preview mode for fast optical alignment
- Data-export as plain-text or Matlab-compatible format
- System housing for laser beam and dust protection
- Open extendable lab-type system platform

The new standard for micron-scale resolution THz imaging on large areas

THE TeraCube Scientific is a fully automated THz near-field scanning system. The system provides a high-efficient source for the optical generation of broadband THz pulses which can be transmitted through planar samples. Spatially and temporally resolved detection of the transmitted pulses in the near-field of sample surfaces is enabled by Protemics TeraSpike microprobes integrated near-field detectors. The system enables measurements on arbitrary surface topographies through active control of the detector/surface distance. It can be driven by an existing or new fs-laser source with suitable specifications.

Application areas

- THz Metamaterial research and sensing application
- Semiconductor wafer inspection
- Sheet resistance imaging
- Graphene analysis
- THz device characterization
- Microstructure analysis
- Non-destructive testing

Protemics GmbH
Otto-Blumenthal-Str. 25
52074 Aachen
Germany

www.protemics.com
info@protemics.com
Phone: +49 241 8867 140
Fax: +49 241 8867 560

new

Technical data

Type	TeraCube Scientific	TeraCube M2
Optical system construction	Free-space beam	Fiber-coupled
Spectral range	0.05 – 3 THz	0.05 – 4 THz
Maximum sample size (x, y, z)	20 cm, 20 cm, 1 cm	
Maximum scanning speed (x, y)	Up to 100 mm/s	
Min. scanning time per pixel	10 ms / Single TDU position	10 ms / Full TD Transient (5ps)
Maximum scanning range (x, y, z)	18 cm, 18 cm, 3 mm	
Time-domain scanning range	1000 ps	5 .. 200 ps
Time-domain step resolution (dt)	6.6 fs	50 fs
Bi-directional repeatability (x, y, z)	+0.1 μ m, +0.1 μ m, +0.15 μ m	

Measurement example

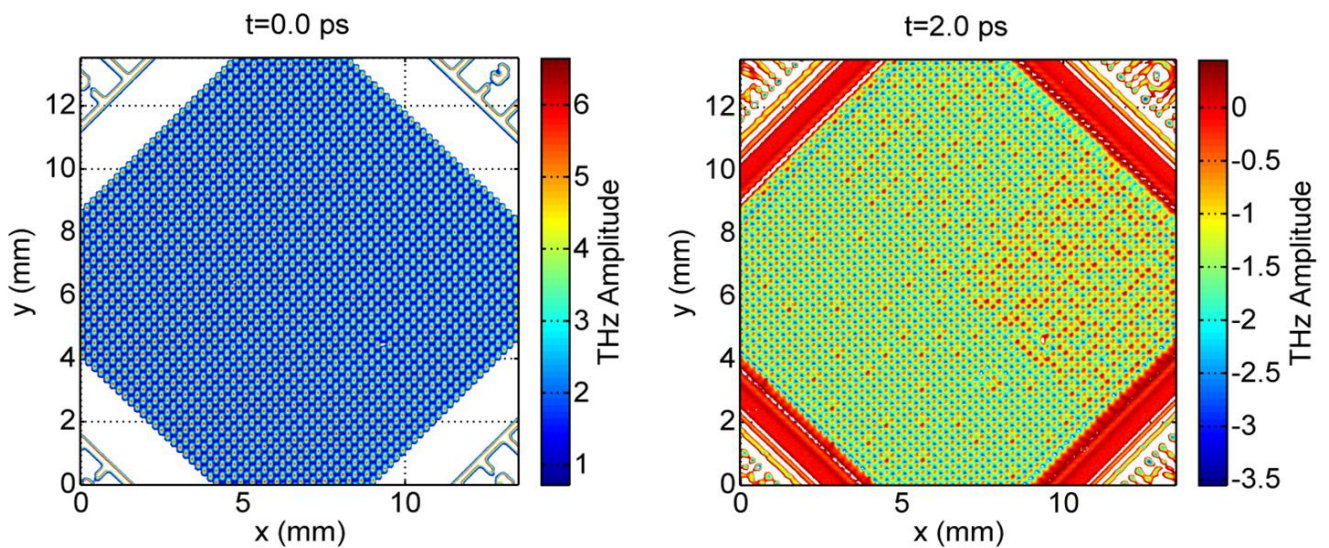

Installation requirements

- Vibration-damped optical table with 1.5m x 1m x 1.5m of space for system placement
- Laser laboratory specification of class 3b or higher

Example plots of the THz near-field distribution measured at a metamaterial surface for sensing applications which is locally loaded with sample material. Left: Peak excitation state, right: 2 ps after excitation.

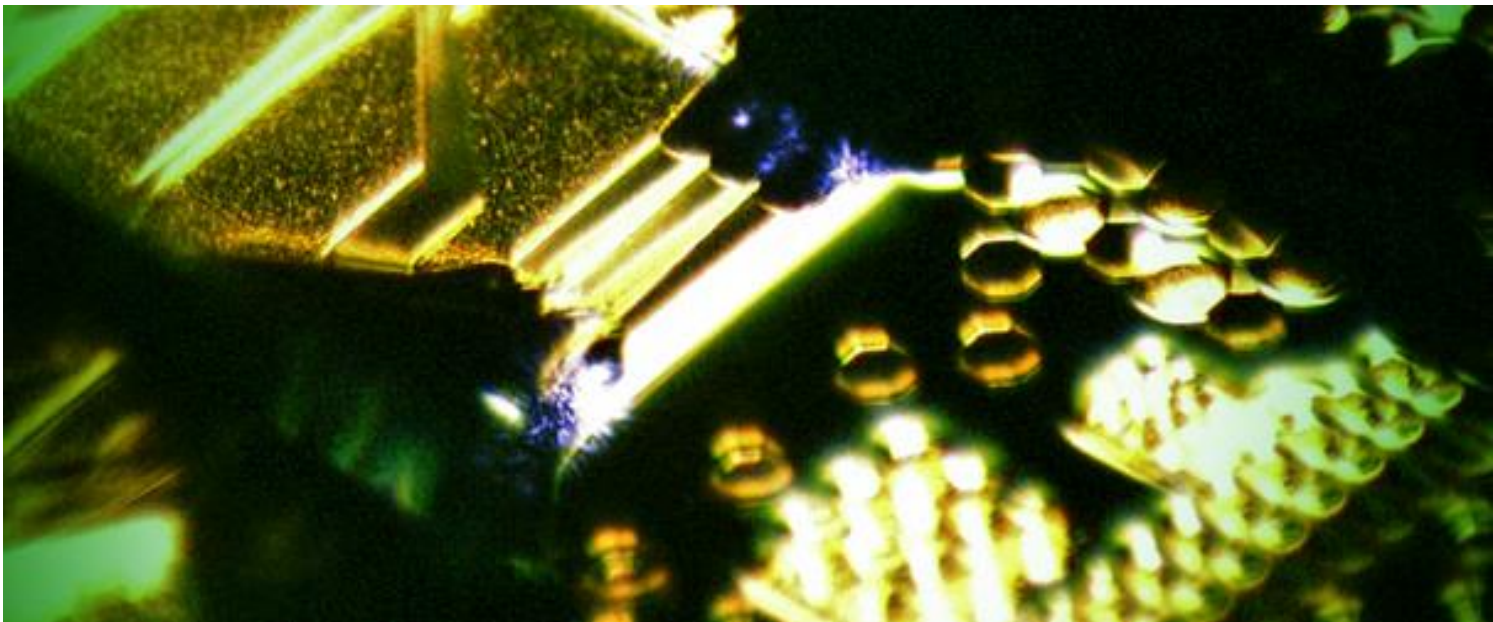

Next generation Terahertz microprobe series

TeraSpike

LT-GaAs photoconductive field detector

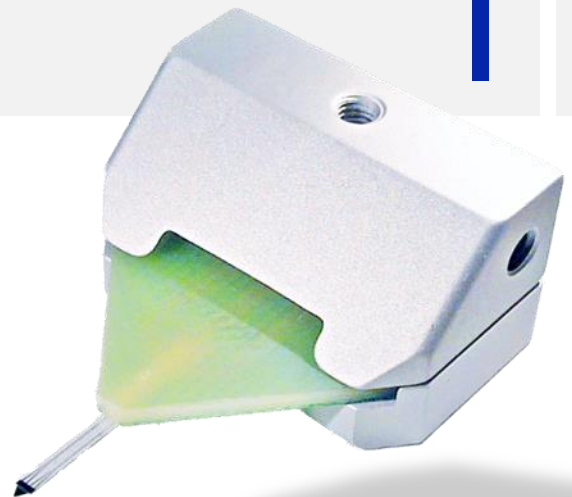

THE microprobe device series TeraSpike has been introduced in 2013. Since then through our customers' feedback and application-driven demands the functional range of the microprobes has been continuously extended. The TeraSpike microprobe is a versatile detector for radiated and surface-near electric fields in the THz frequency-range offering unprecedented performance, robustness and applicability. It is the key component of the TeraCube Scientific near-field scanning system. Furthermore, it seamlessly fits into most other THz time-domain systems with optical excitation wavelengths below 860 nm. It is the most cost-efficient solution to turn your system into a powerful high-resolution near-field THz system.

Your laser-based THz system can do much more than just spectroscopy – discover the fascinating world of high-resolution THz applications!

Key features

- Smallest active THz probe-tip on the market with only 1 μm cantilever thickness based on a patented design (DE 10 2009 000 823.3)
- Spatial resolution up to 3 μm
- Frequency range 0 – 4 THz
- Adaptable to all laser-based THz-Systems with $\lambda < 860 \text{ nm}$
- Mounting compatible with standard opto-mechanical components
- Required optical excitation power $< 1 \text{ mW}$

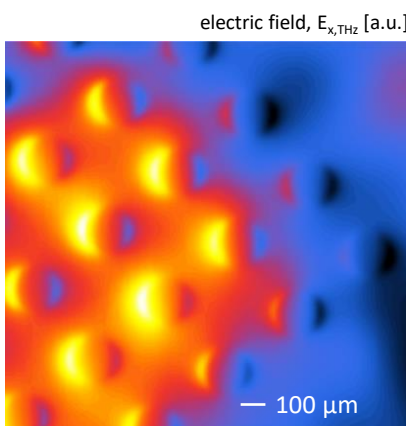

Measured near-field image of a pulse-excited THz metamaterial surface.

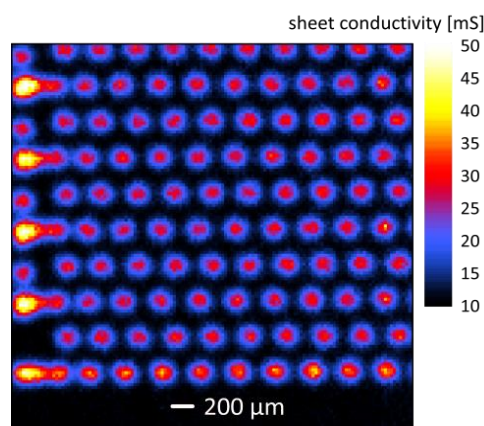

Measured sheet conductivity image of a laser-doped multicrystalline silicon wafer.

Applications

- Terahertz research: Metamaterials, plasmonics, graphene, waveguides, ...
- High-resolution Terahertz near-field imaging
- Contact-free sheet resistance imaging of semiconductors
- MMIC device characterization
- Non-destructive chip inspection
- Time-domain reflectometry (TDR)

Transversal field microprobes

TeraSpike TD-800-X

电话: 0755-84870203
 邮箱: sales@highlightoptics.com



Technical data

TeraSpike TD-800-X-	HR	HRS
Max. spatial resolution	3 μm	20 μm
PC gap size	1.5 μm	2 μm
Dark current @ 1 V Bias	< 0.5 nA	< 0.5 nA
Photocurrent (*)	> 0.2 μA	> 0.2 μA
Excitation wavelength	700 .. 860 nm	
Avg. excitation power	0.1 .. 4 mW	
Connection type	SMP	

Product details

- Photoconductive probe-tip with integrated overvoltage protection optimized for pulsed excitation
- Mount for variable probe orientation
- Simple & safe probe removal from the set-up
- Robust probe storage box
- Test certificate & manual

Accessories

- SMP to SMA/BNC cable connection
- Photo-current amplifier
- Probe-tip dummy structure
- Mounting & focusing units
- Starter Kit

(*) For a focus diameter of circa 20 μm , bias voltage 1 V, average optical excitation power 3 mW.

Set-up (exemplary for near-field transmission measurements)

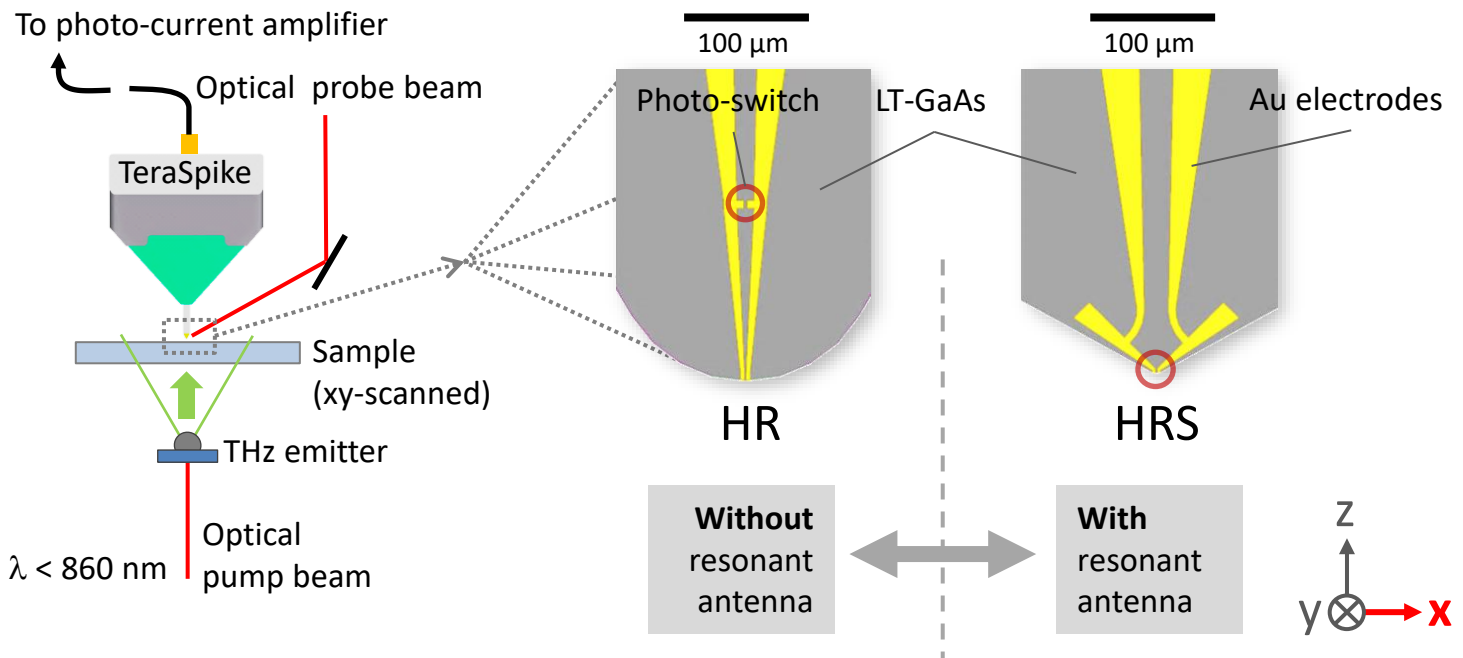

All TD-800-X probes are sensitive to **x-oriented** field components

TeraSpike TD-800-X

Time-domain measurement data (HR)*

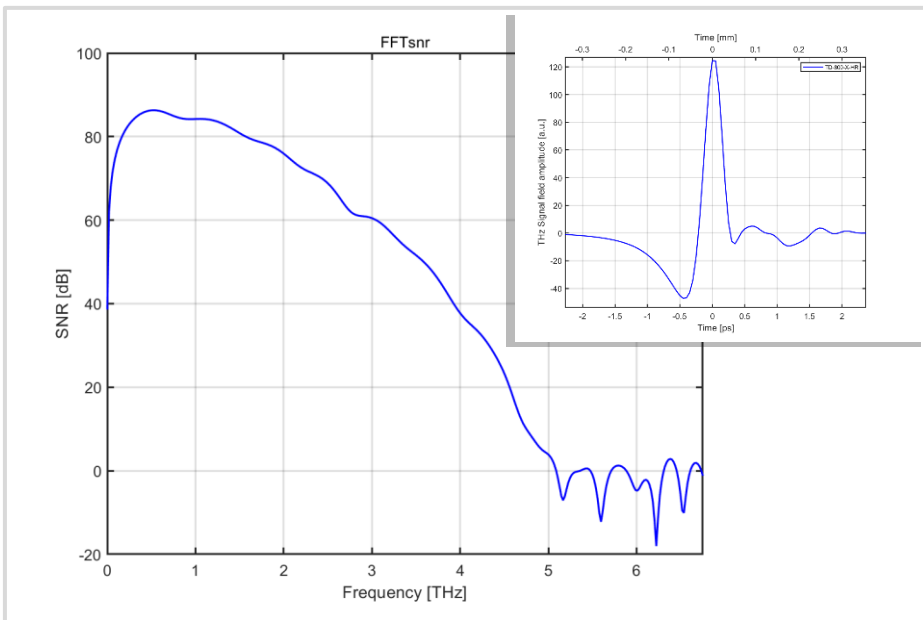

* Measured with TeraCube Scientific M2

The diagram illustrates the HR measurement setup. A yellow beam is focused through a lens onto a target area labeled 'HR'. The beam is shown as a narrow, vertical line, indicating high spatial resolution.

Key feature:

- Highest spatial resolution
- Highest bandwidth

Terahertz measurement data (HRS)*

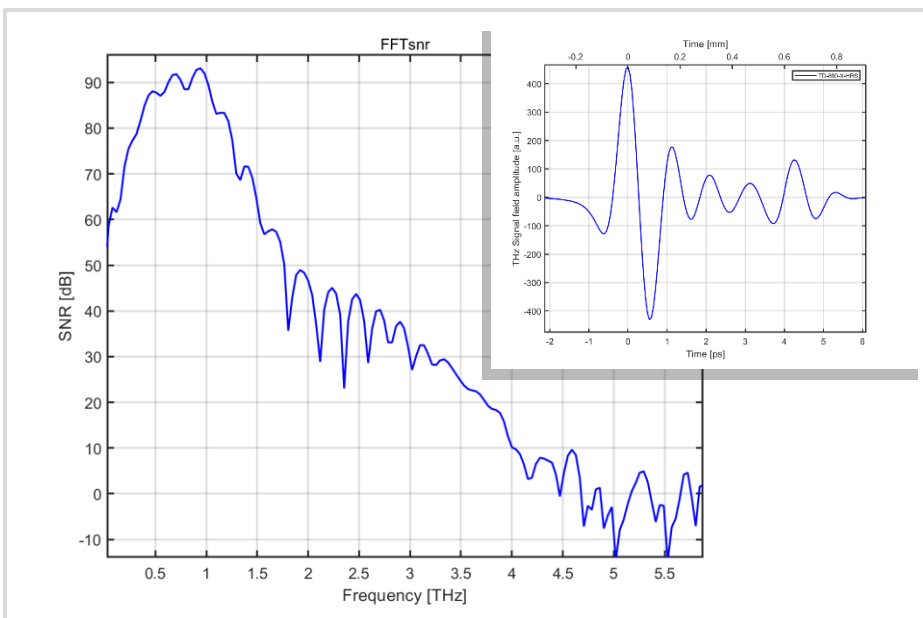

* Measured with TeraCube Scientific M2

The diagram illustrates the HRS measurement setup. A yellow beam is focused through a lens onto a target area labeled 'HRS'. The beam is shown as a wider, vertical line, indicating higher sensitivity for a specific frequency range.

Key feature:

- Highest sensitivity for $0.5 \text{ THz} < f < 1.3 \text{ THz}$

TeraSpike TD-1550-X-HR-WT



电话: 0755-84870203

邮箱: sales@highlightoptics.com

Technical data

TeraSpike TD-1550-X-	HR-WT	HR-WT-XR
Max. spatial resolution	40 μ m (20 μ m (#))	80 μ m
PC gap size	1.5 μ m	1.5 μ m
Dark current @ 1 V Bias	< 4 μ A	< 4 μ A
Photocurrent (*)	> 10 μ A	> 10 μ A
Excitation wavelength	1500 .. 1600 nm	1500 .. 1600 nm
Avg. excitation power	1.5 .. 3 mW	1.5 .. 3 mW
Connection type	SMP	SMP

Product details

- Photoconductive probe-tip with integrated overvoltage protection optimized for pulsed excitation
- Mount for variable probe orientation
- Simple & safe probe removal from the set-up
- Robust probe storage box
- Test certificate & manual

Accessories

- SMP to SMA/BNC cable connection
- Photo-current amplifier
- Probe-tip dummy structure
- Mounting & focusing units
- Starter Kit

(*) For a focus diameter of circa 20 μ m, bias voltage 1 V, average optical excitation power 2.5 mW.

(#) For front-switch instead of main-switch excitation. Front-switch excitation mode is showing reduced SNR.

Set-up (exemplary for near-field transmission measurements)

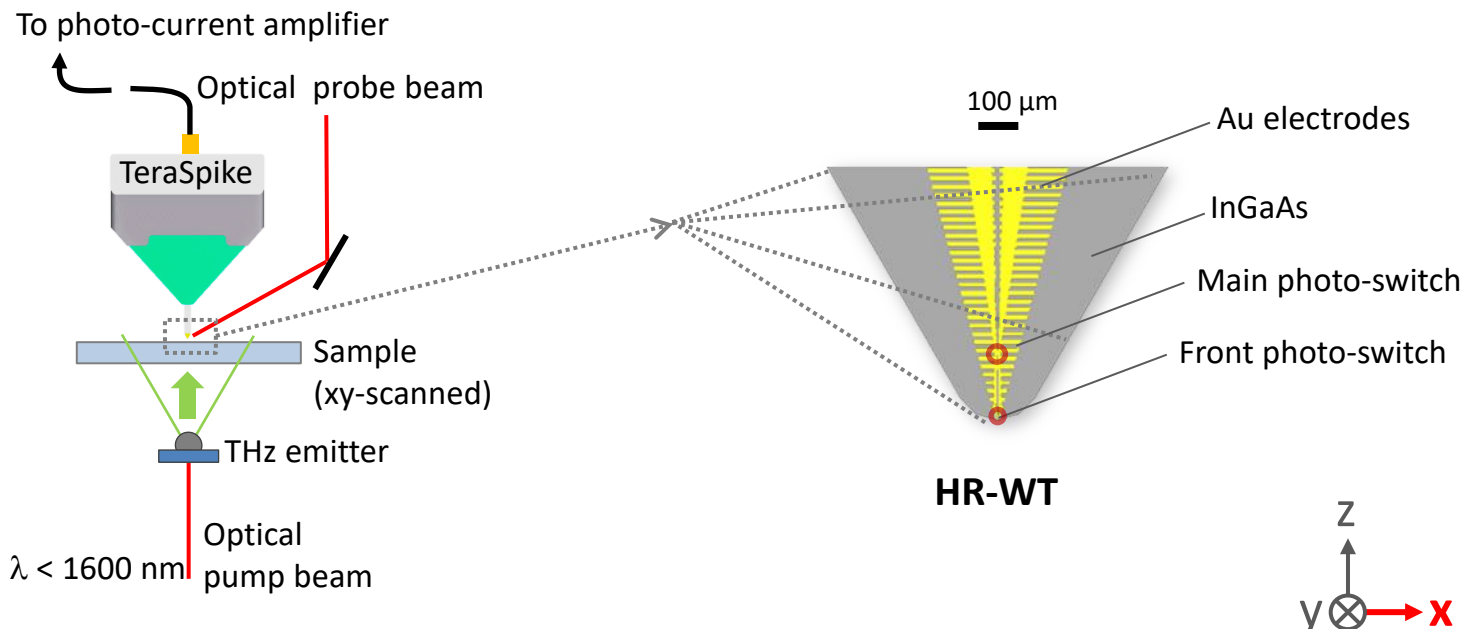

All TD-1550-X probes are sensitive to **x-oriented** field components



Time-domain measurement data

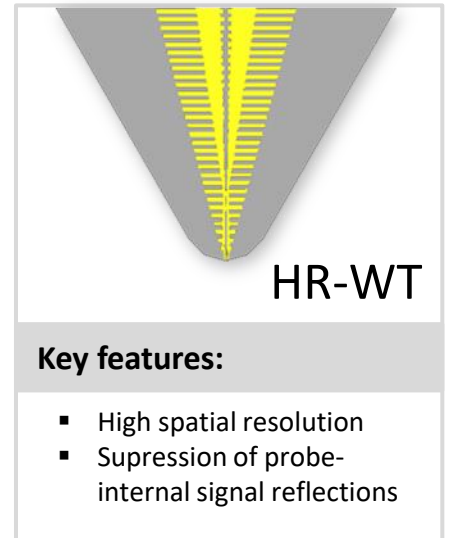
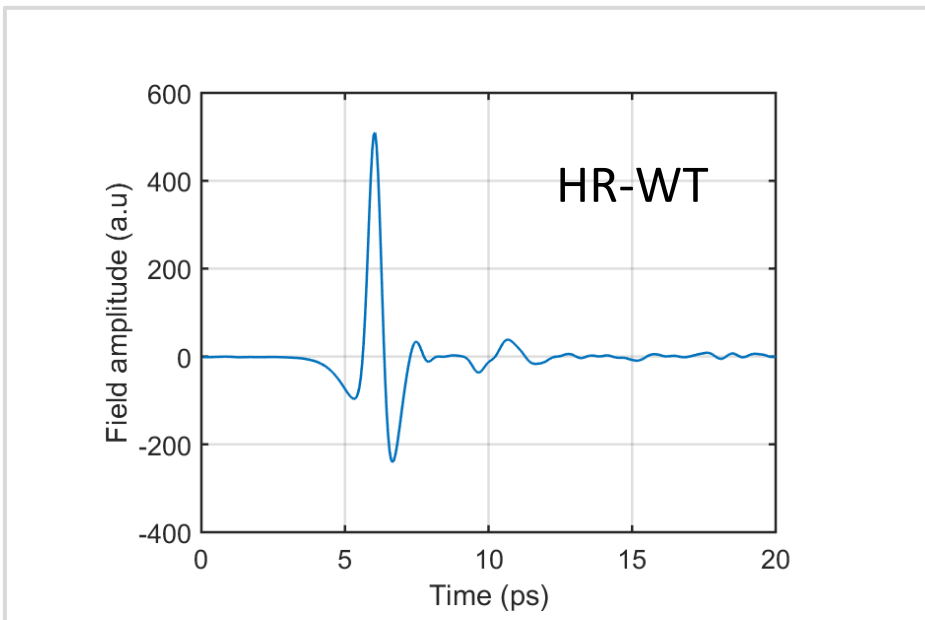

Frequency-domain measurement data

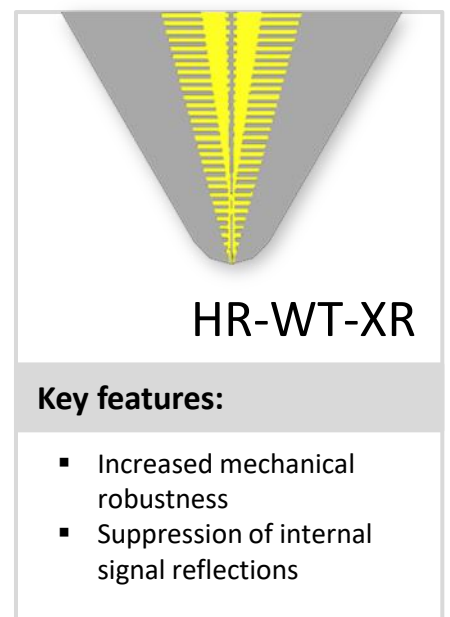
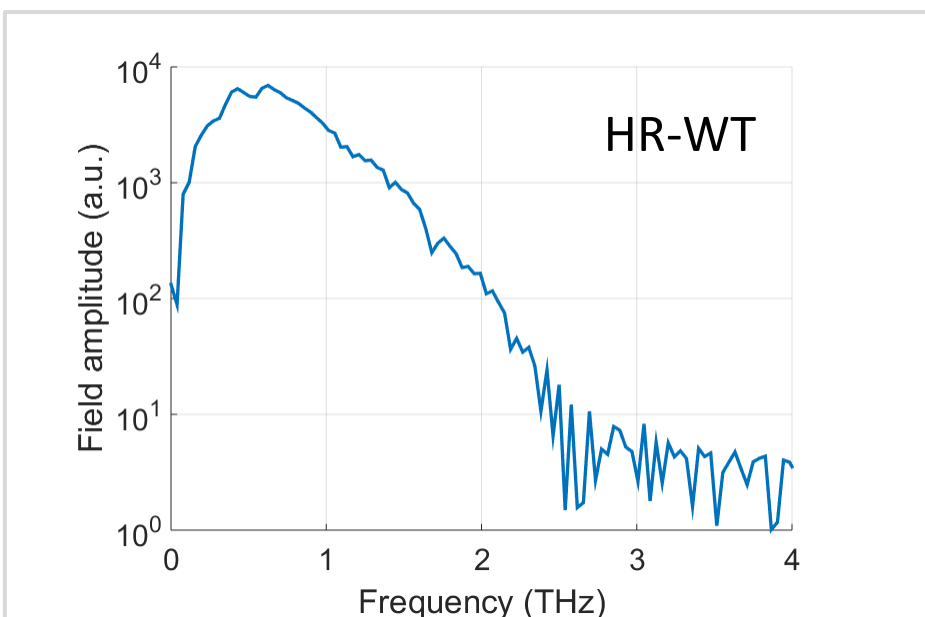

Longitudinal field microprobes

TeraSpike TD-800-Z

Technical data

TeraSpike TD-800-	A-500G	N / WT
Max. spatial resolution	8 μm	8 μm
PC gap size	5 μm	2 μm
Dark current @ 1 V Bias	< 0.4 nA	< 0.4 nA
Photocurrent (*)	> 0.2 μA	> 0.1 μA
Excitation wavelength	700 .. 860 nm	700 .. 860 nm
Avg. excitation power	0.1 .. 4 mW	0.1 .. 4 mW
Connection type	SMP	SMP

(*) For a focus diameter of circa 20 μm , bias voltage 1 V, average optical excitation power 3 mW.

Time-domain (FFT) data

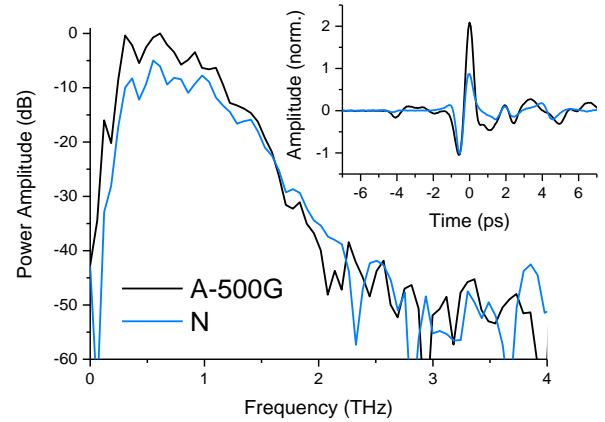

Spatial resolution

THz z-field scan across test structure

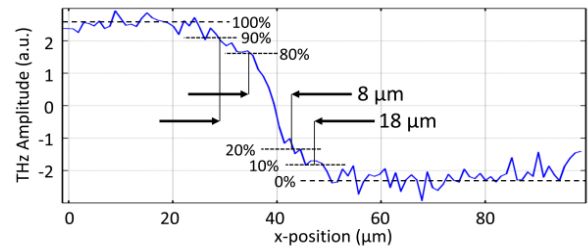

Tip design options

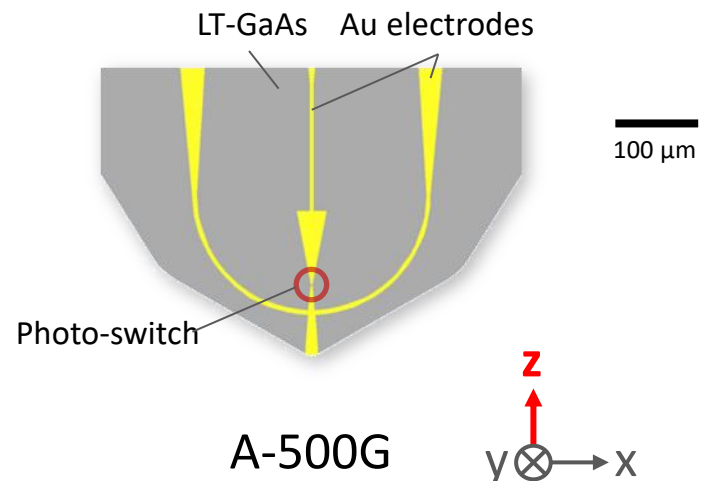
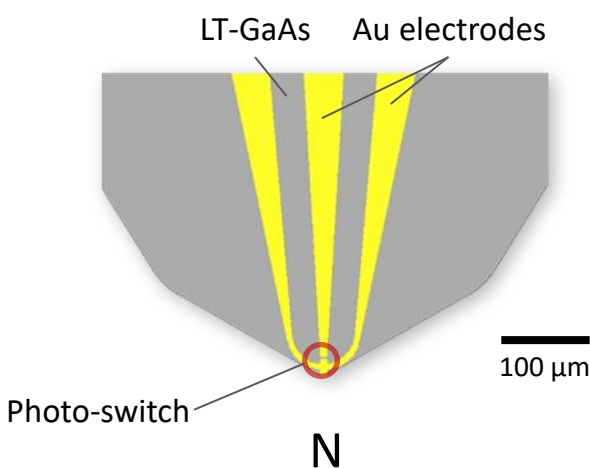

All TD-800-Z probes are sensitive to **z-oriented** field components

Measurement example: 3D vector field mapping

THz field data

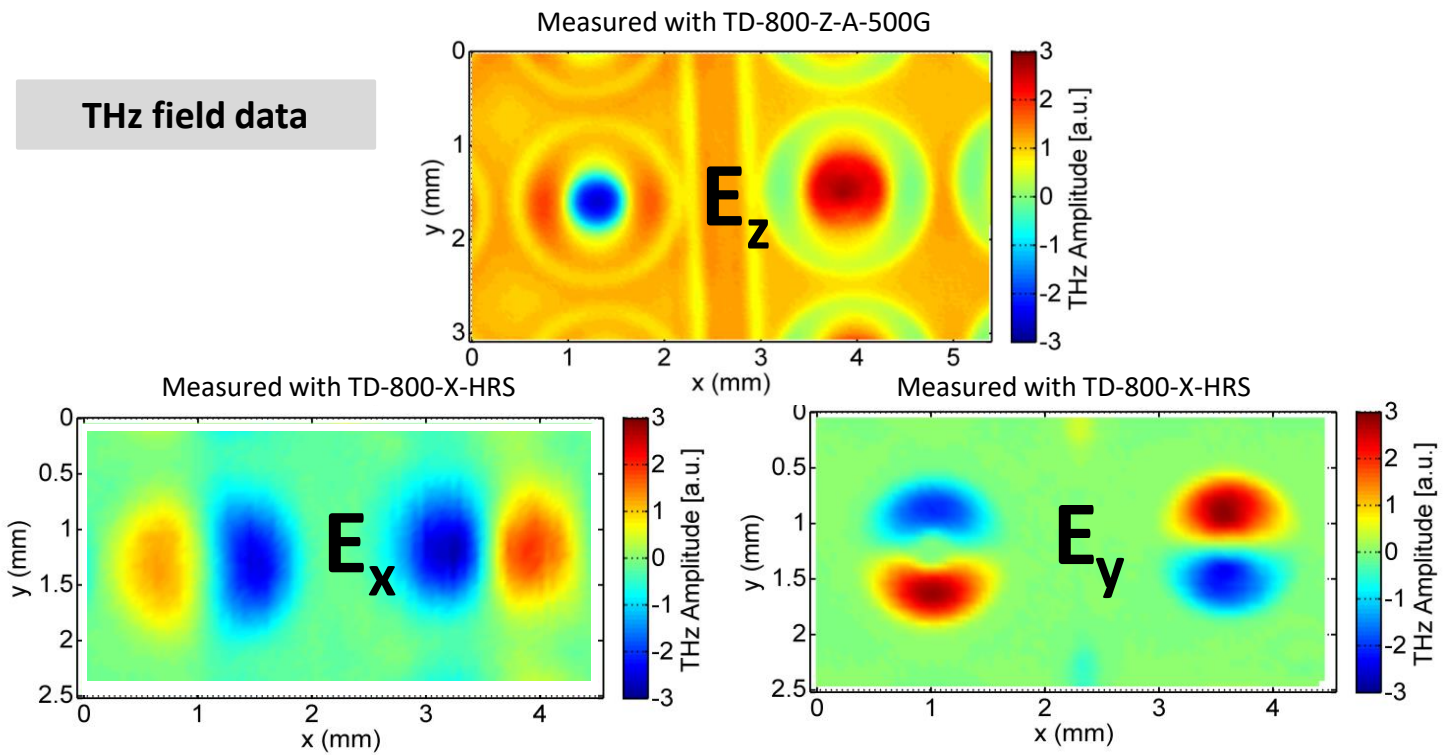

Device under test: Radial-mode emitter pair

Device cross-section:

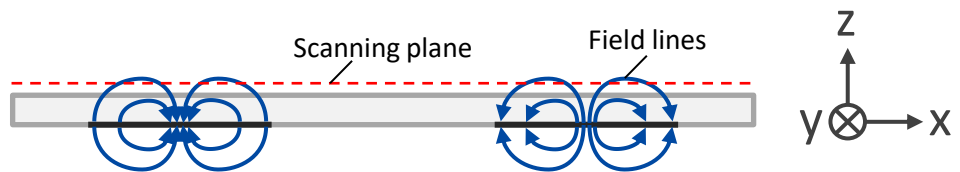

Zoom to center regions:

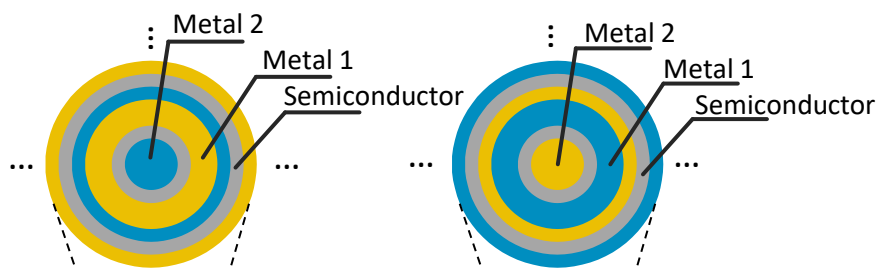

Device top-view:

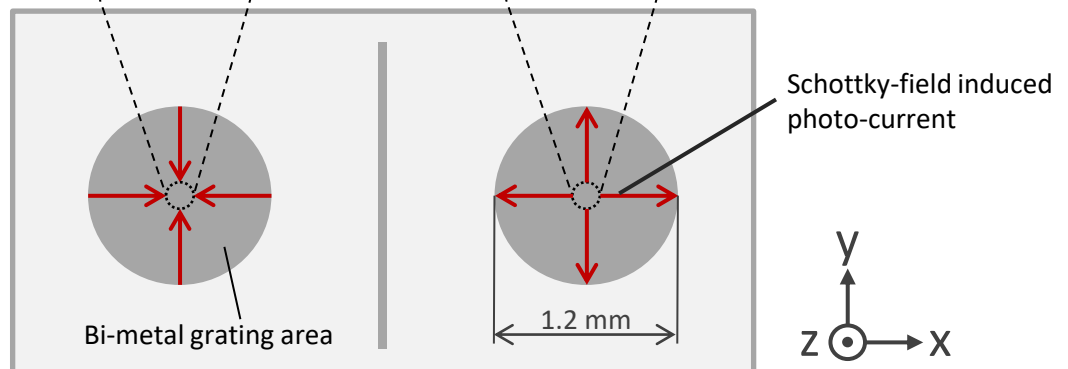

Pair of radial-mode THz emitters based on planar bi-metal gratings

Reflection-mode THz near-field probes

TeraSpike transceivers

TR.5
THz reflection

new

TSR.75
THz surface reflection

new

TSR-TT.75
THz surface reflection +
THz transmission

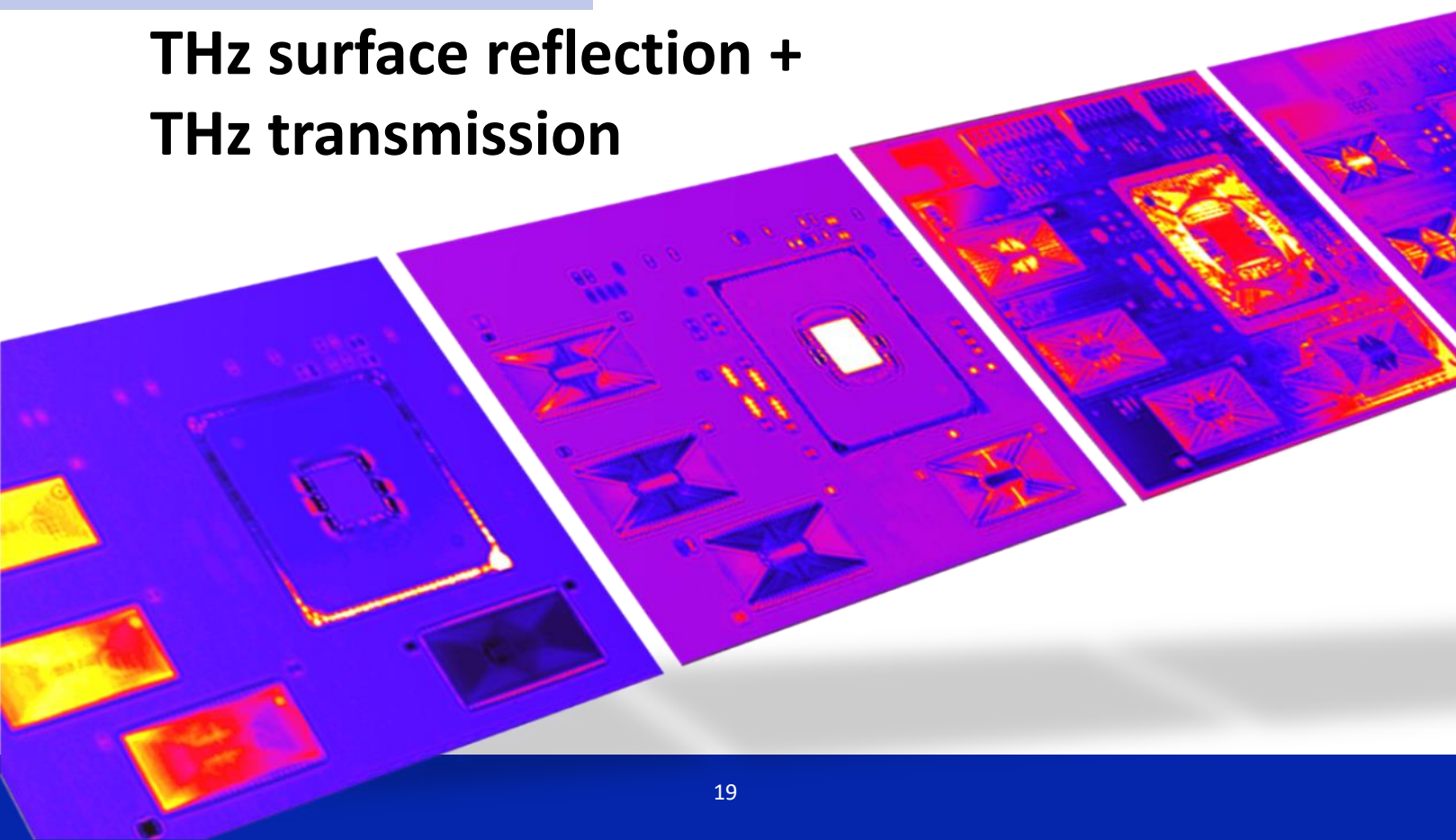

TR.5, TSR.75 and TSR-TT.75 CPS-based THz-design

Front-end probe schematics

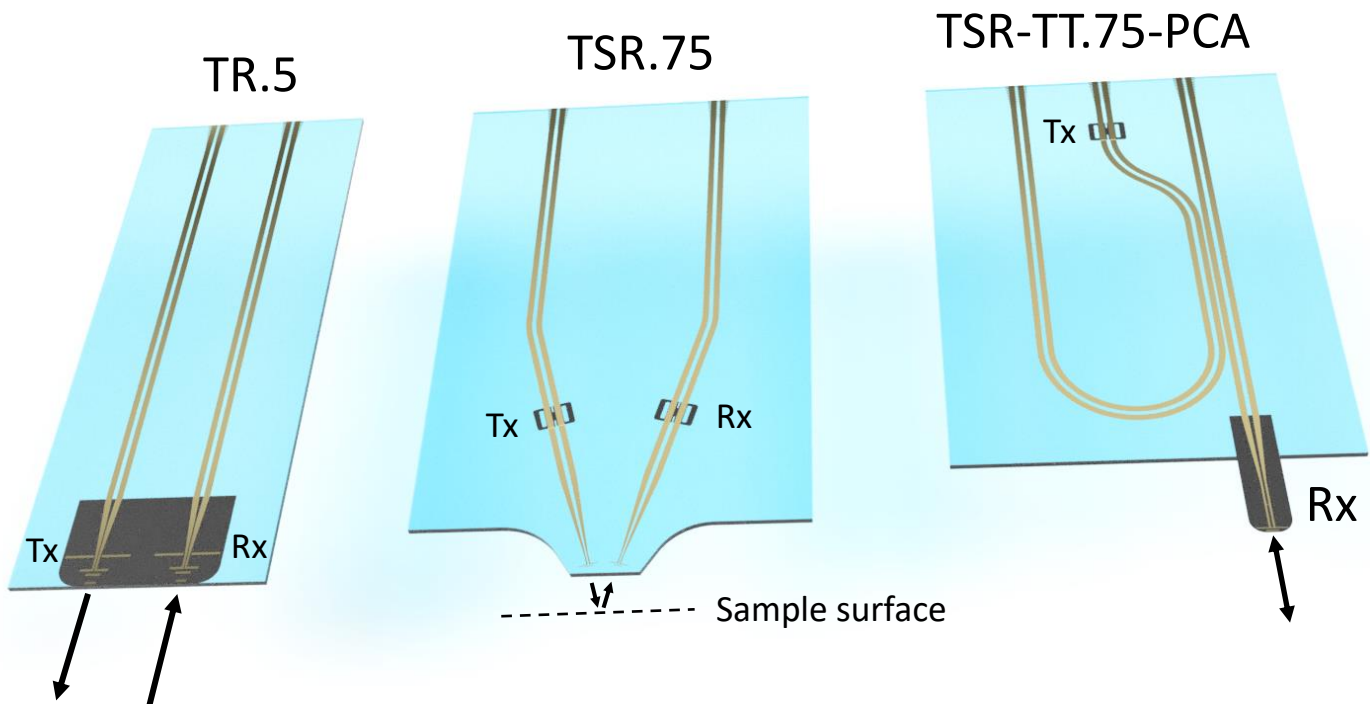

Comparison chart

Model	Operation mode	# of Ant.	Incidence angle [deg]	Band-width [THz]	Spatial Resol. [μm]
TD-800-TR.5	Reflection	2	0	1.5	250
TD-800-TSR.75-PCS10-50	Reflection	2	15	3	100
TD-800-TSR-TT.75-PCA-PCS10-50	Reflection and Transmission	1	0	2	40

Reflexion-mode near-field transceiver TeraSpike TD-800-TR.5

THE TeraSpike model TR.5

comes with a pair of closely spaced photoconductive THz antennas offering new means for high-performance near-field measurements in reflection-mode. While one antenna is used as a THz pulse generator, the other antenna is used as the detector.

The slim transceiver probe is taking advantage of Proteemics' proprietary "wave-trap" design for the suppression of probe-internal reflection signals as well as the **XR-type** flexible PET cantilever design for increased mechanical robustness. In contrast to standard reflection-mode approaches based on far-field emitter/detector components the new near-field transceiver probe provides access to sub-wavelength-resolution and shortest THz transmissions paths.



Time-domain measurement examples

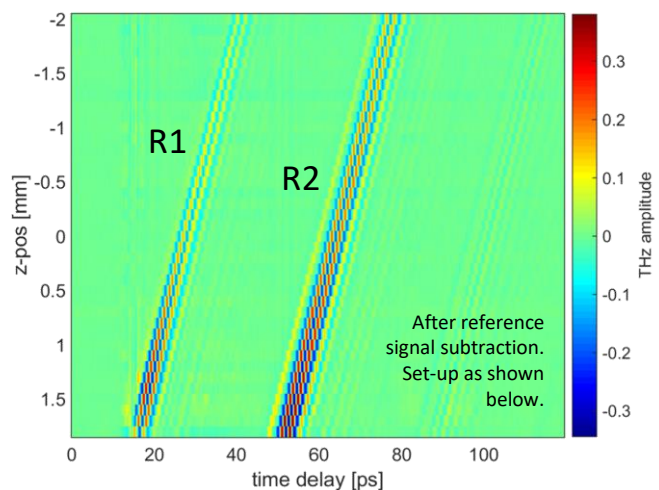
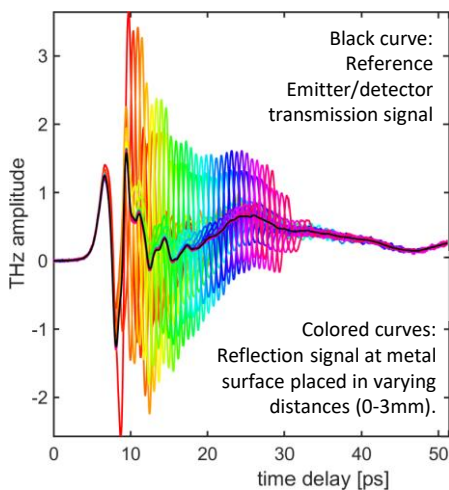

Tip design and set-up

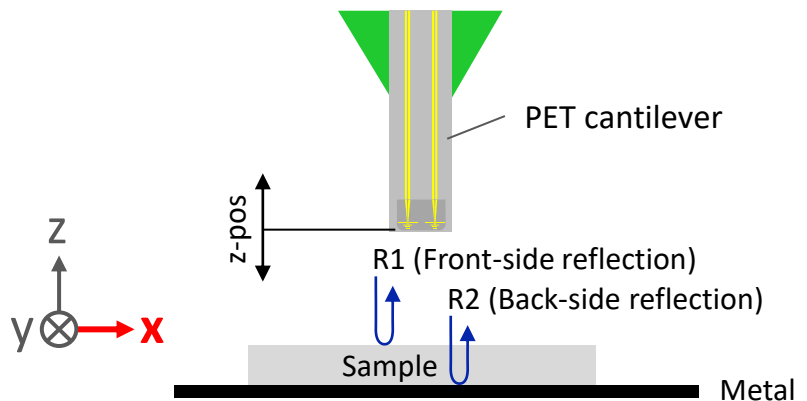
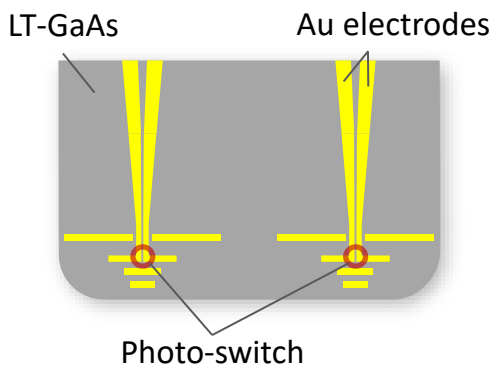

Terahertz sensor head solution TD-800-TR.5 for Non-destructive Testing

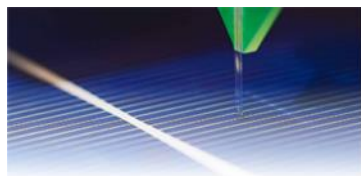

Reflection imaging examples

Conduction layers: Solar cells

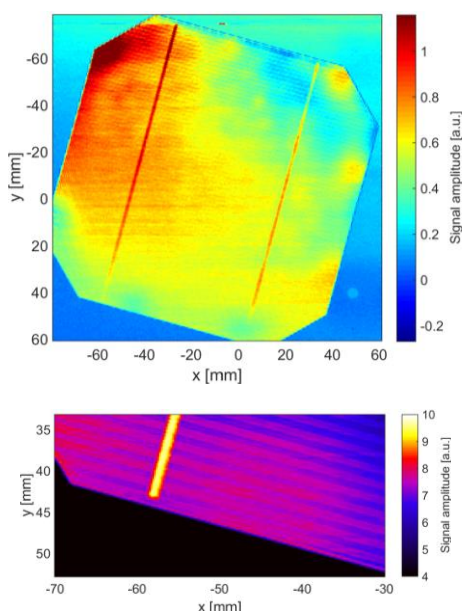

Buried plastic welds

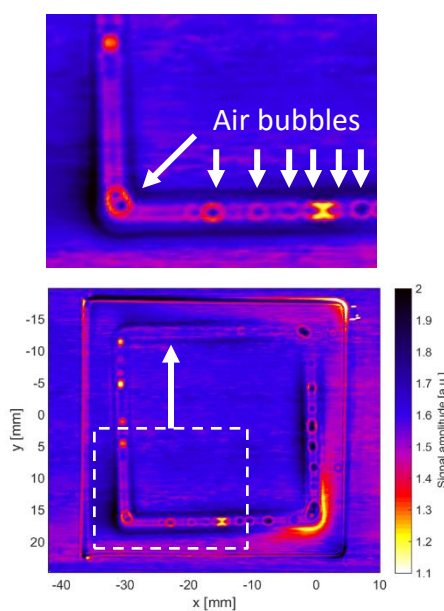

Key benefits

- Includes THz emitter and detector
- Reflection-mode measurements
- Ideal for **opaque or bulky samples** not measurable in transmission-mode
- Ideal for large scanning areas using moving probe instead of moving sample set-ups

Product details

- Photoconductive probe-tip with integrated overvoltage protections optimized for pulsed excitation
- Mount for variable probe orientation
- Simple & safe probe removal from the set-up
- Robust probe storage box
- Test certificate & manual

Technical data

TeraSpike TD-800-	TR.5
Dark current @ 1 V Bias	< 1.5 nA
Photocurrent (*)	> 0.5 μ A
Excitation wavelength	700 .. 860 nm
Avg. excitation power	0.1 .. 4 mW
Connection type	2x SMP

(*) For a focus diameter of circa 30 μ m, bias voltage 1 V, average optical excitation power 3 mW.

Accessories

- SMP to SMA/BNC cable connection
- Photo-current amplifier
- Probe-tip dummy structure
- Mounting & focusing units
- Starter Kit

Reflexion-mode near-field transceiver TeraSpike TD-800-TSR.75

new

THE new TeraSpike model TSR.75 features a pair of photoconductive THz antennas optimized for **surface-near reflection-mode** operation. The beam incidence angle established by the orientation of the integrated antennas is 15°. As for the TR.5 model one antenna is used as a THz pulse generator, the other antenna is used as the detector. The TSR is also taking advantage of Protemics' proprietary **"wave-trap"** design for the suppression of probe-internal reflection signals as well as the **XR-type** flexible cantilever design for increased mechanical robustness. In contrast to standard reflection-mode approaches based on far-field emitter/detector components Protemics near-field transceiver probe provides access to sub-wavelength-resolution and shortest THz transmissions paths.



Time- & Frequency-domain response

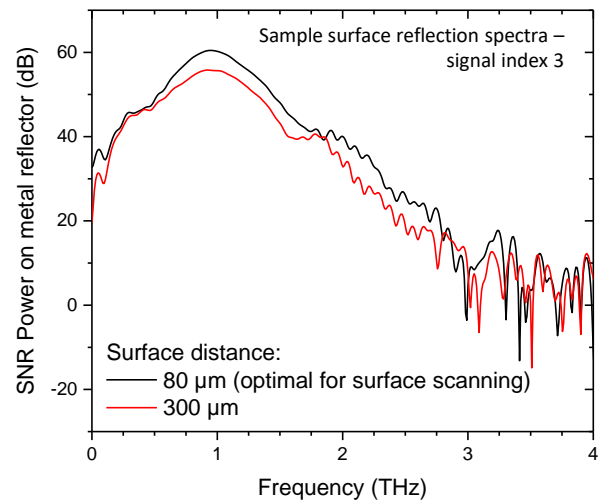
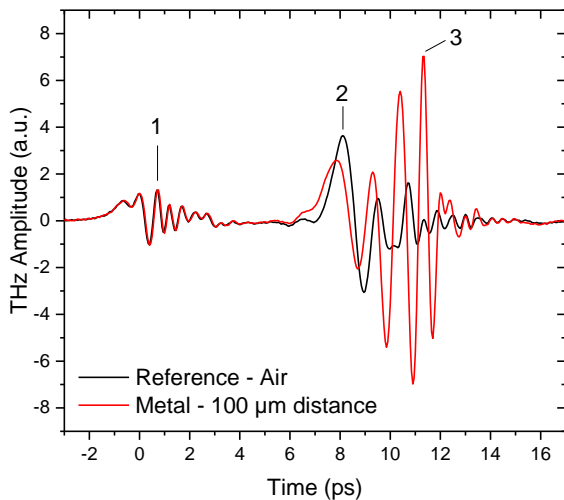

Time-domain signal index: 1 – Internal transmission, 2 – Antenna-Antenna coupling, 3 – Sample surface reflection (see also scheme below). Applied averaging factor: 80

Tip design and set-up

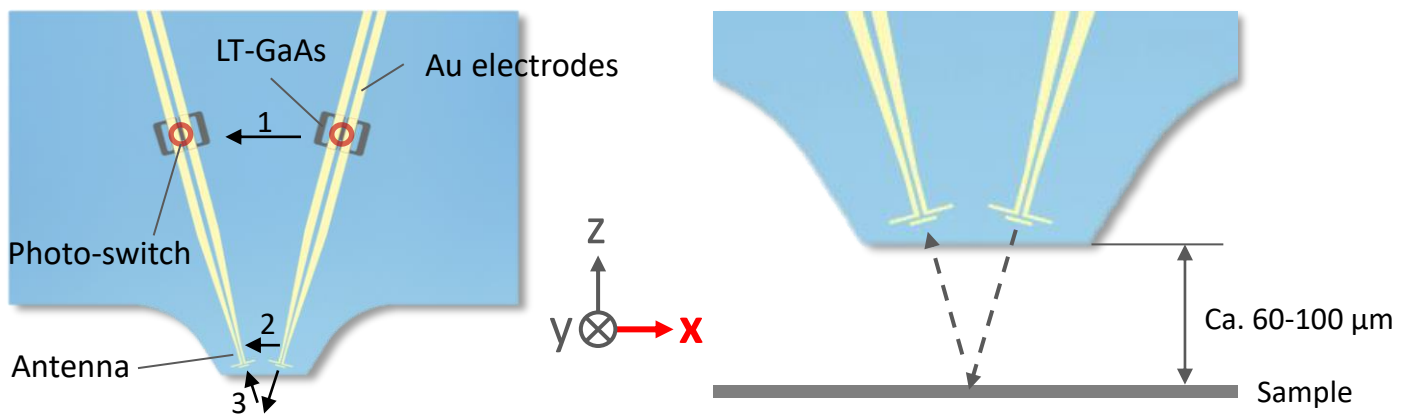

Terahertz microprobe solution for Surface-near volume inspection

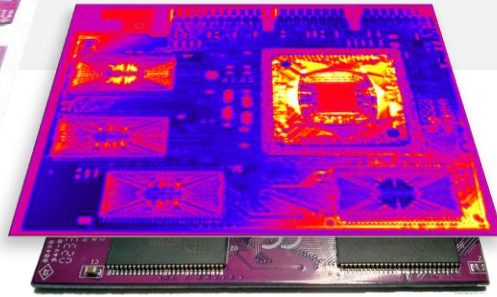

*Sample ICs courtesy of Dr. Asadi's group, Florida Institute for Cybersecurity Research (FICS)

Application example: IC authenticity verification*

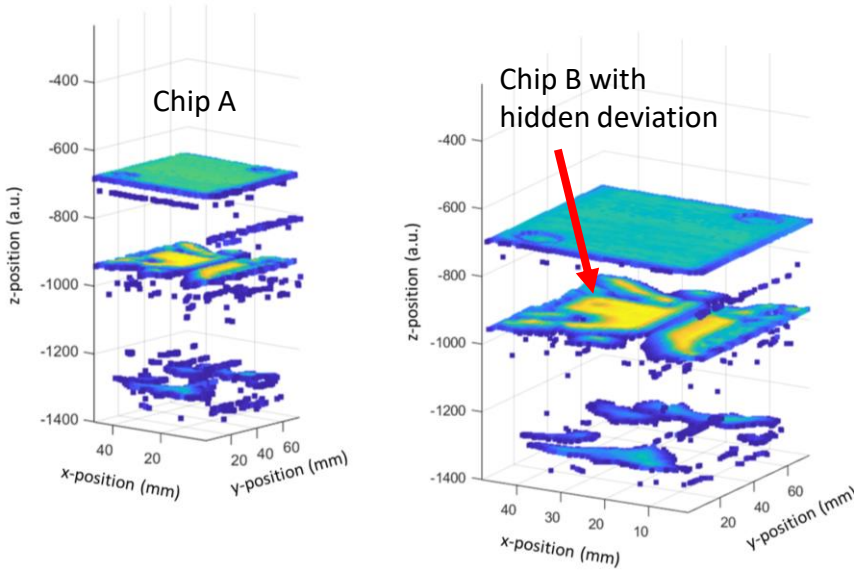

Stacked interface and buried structure localization based on the software package **Teraloc** - optimized for TeraSpike-probes.

Technical data

TeraSpike TD-800-	TRS.75-PCS10-50
Dark current @ 1 V Bias	< 10 nA (typ. <1.5 nA)
Photocurrent (*)	> 0.1 μ A (typ. >0.25 μ A)
Excitation wavelength	700 .. 860 nm
Avg. excitation power	0.1 .. 3 mW
Connection type	2x SMP

(*) For a focus diameter of circa 30 μ m, bias voltage 1 V, average optical excitation power 3 mW. The recommended Tx bias voltage during THz measurements is 9V.

Key benefits

- Includes THz emitter and detector
- Reflection-mode measurements
- Ideal for **opaque or bulky samples** not measurable in transmission-mode
- Ideal for large scanning areas using moving probe instead of moving sample set-ups

Product details

- Photoconductive probe-tip with integrated overvoltage protections optimized for pulsed excitation
- Mount for variable probe orientation
- Simple & safe probe removal from the set-up
- Robust probe storage box
- Test certificate & manual

Accessories

- SMP to SMA/BNC cable connection
- Photo-current amplifier
- Probe-tip dummy structure
- Mounting & focusing units
- Starter Kit

TeraSpike TD-800-TSR-TT.75



THE new TeraSpike model TSR-TT.75 is based on our patent pending design (Patent application DE102020002735A1) featuring a single front-end antenna for reflection- and transmission-mode operation. The probe enables a beam incidence in surface-normal direction. THz signals for reflection-mode operation are fed from a dc-decoupled emitter switch to the antenna through a broad-band directional coupler element. Both, front-end antenna and the emitter switch are based on LT-GaAs. The TSR-TT is also taking advantage of Protemics' proprietary "**wave-trap**" design for the suppression of probe-internal reflection signals as well as optionally the **XR-type** flexible cantilever design for increased mechanical robustness. Thanks to the single antenna design the TSR-TT is offering the highest spatial resolution of all reflection-mode probes in our product family.

Time- and frequency-domain measurement examples

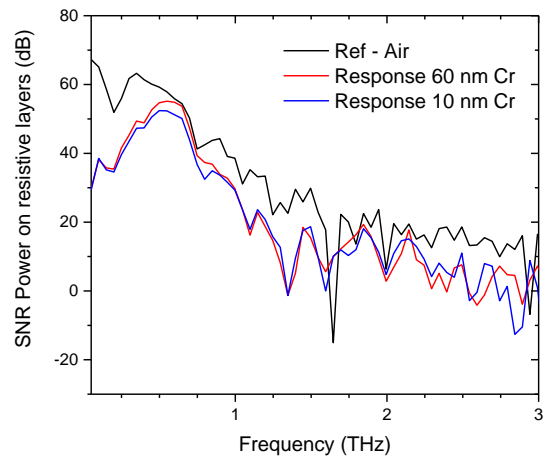
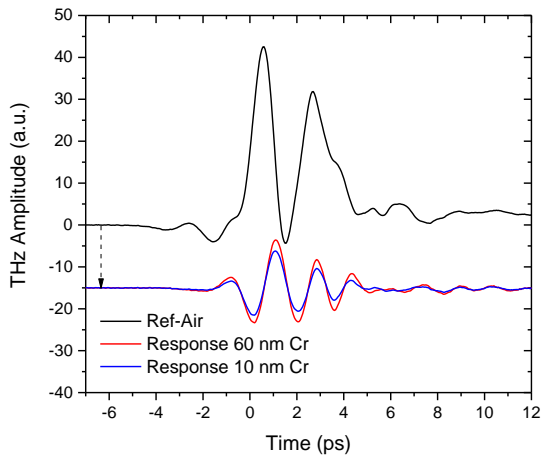

Measured at Siemens-star on test target P-TTT-2-1200. Response signals are subtracted by Ref-Air signal measured without sample. Applied averaging factor: 25 - Rx photo-switch 1.

Tip design and set-up

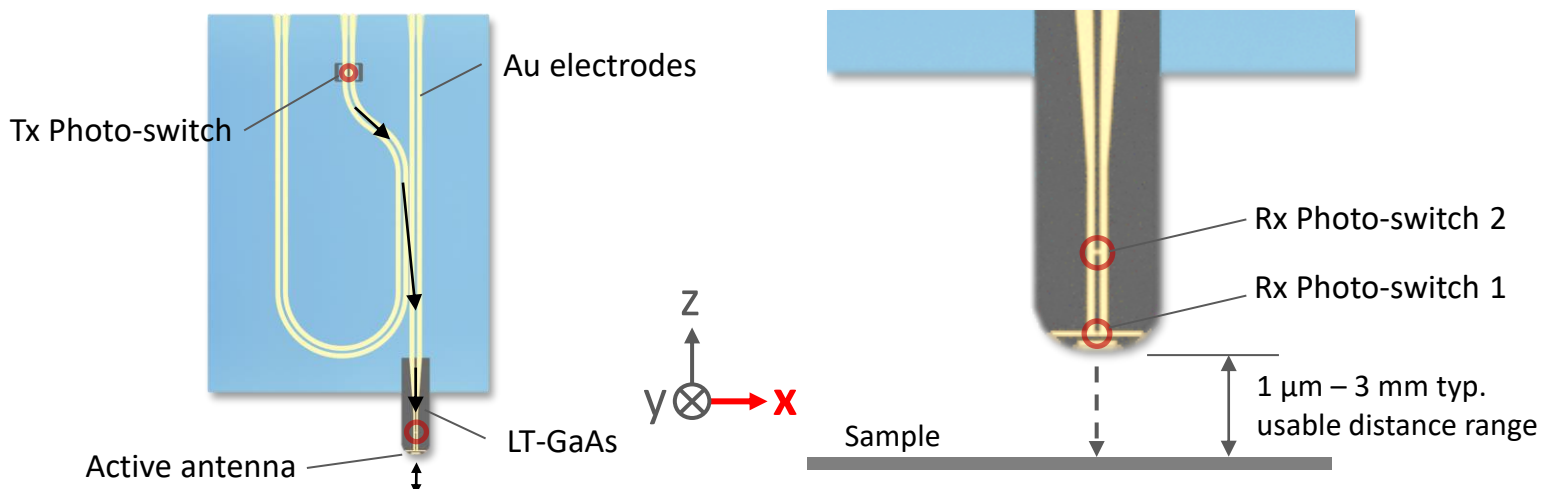

Terahertz transceiver TD-800-TSR-TT.75 for High-resolution surface imaging

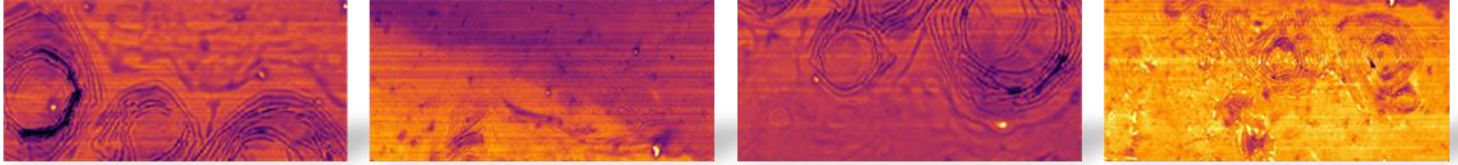

Reflection imaging examples

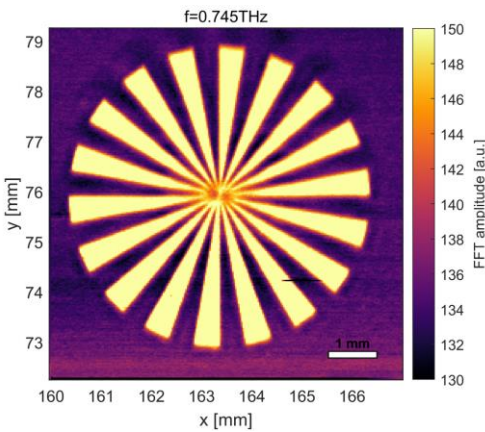

Measured in ca. 5-10 μm vertical distance.

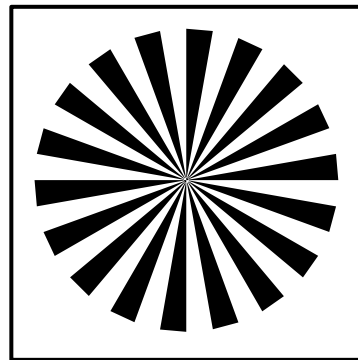

Siemens star on test target:
P-TTT-2-1200 (Protemics)

Key benefits

- Includes THz emitter and detector
- Reflection- and transmission-mode measurements
- Ideal for **opaque or bulky samples** not measurable in transmission-mode
- Ideal for large scanning areas using moving probe instead of moving sample set-ups

Technical data

TeraSpike TD-800-	TRS-TT.75-PCA-PCS10-50
Dark current @ 1 V Bias	< 10 nA (typ. <1.5 nA)
Photocurrent (*)	> 0.1 μA (typ. >0.3 μA)
Excitation wavelength	700 .. 860 nm
Avg. excitation power	0.1 .. 3 mW
Connection type	2x SMP

Operation mode	# of Ant.	Incidence angle [deg]	Band-width [THz]	Spatial Resol. [μm]
Refl. and Transm.	1	0	2	40

Product details

- Photoconductive probe-tip with integrated overvoltage protections optimized for pulsed excitation
- Mount for variable probe orientation
- Simple & safe probe removal from the set-up
- Robust probe storage box
- Test certificate & manual

Accessories

- SMP to SMA/BNC cable connection
- Photo-current amplifier
- Probe-tip dummy structure
- Mounting & focusing units
- Starter Kit

(*) For a focus diameter of circa 30 μm , bias voltage 1 V, average optical excitation power 3 mW. The recommended Tx bias voltage during THz measurements is 9V.

On-chip THz time-domain spectroscopy

TeraLineX TD-800-CPS

THE new TeraLineX is a revolutionary on-chip THz time-domain spectroscopy (TDS) platform that enables the characterization of micron-scale devices and samples at THz frequencies. Unlike conventional THz TDS systems, TeraLineX can enable THz measurements at sub-wavelength scales with enhanced sensitivity, opening up new possibilities for THz spectroscopy of micro- or nanoscale samples.

The TeraLineX can also operate in challenging environments, such as low temperatures or high magnetic fields, thanks to its compact and robust design. TeraLineX supports exchangeable daughter-boards as sample carriers, which allow for cost-efficient and flexible operation. Moreover, it can be customized on request to meet your specific needs. TeraLineX is the ultimate solution for on-chip THz TDS.



Time- and frequency-domain measurement performance*

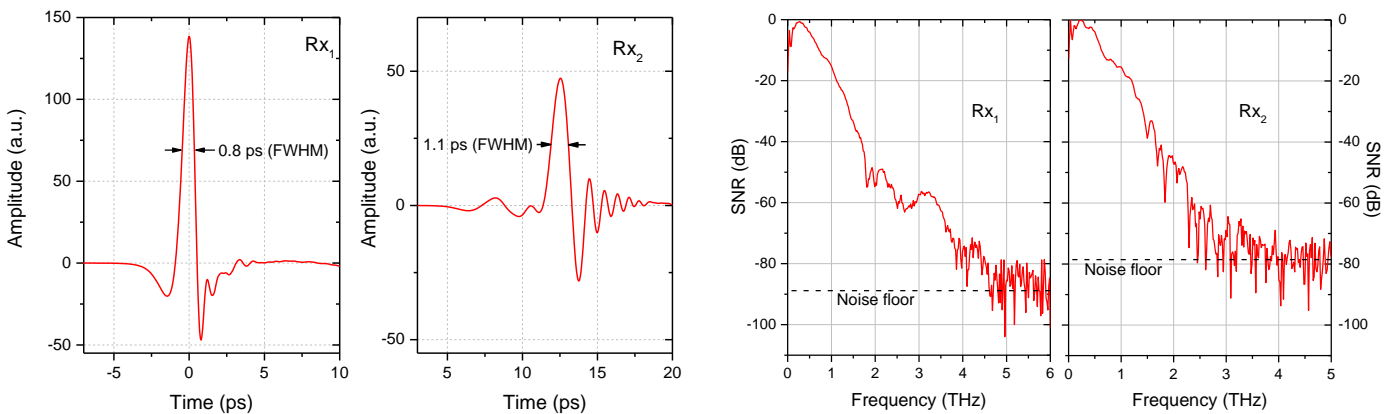

*Measured with an amplifier gain of 10^8 V/A and a fast-scan averaging factor of 10^3 .

THz design and set-up

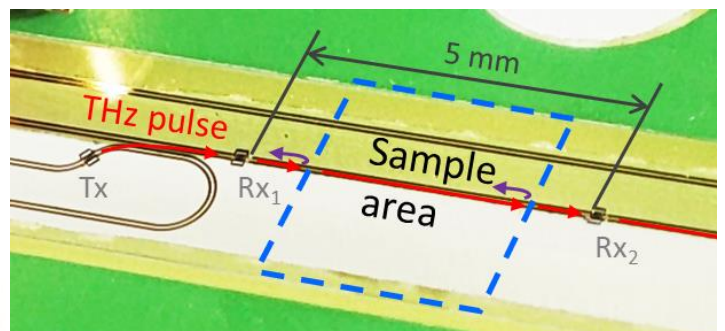
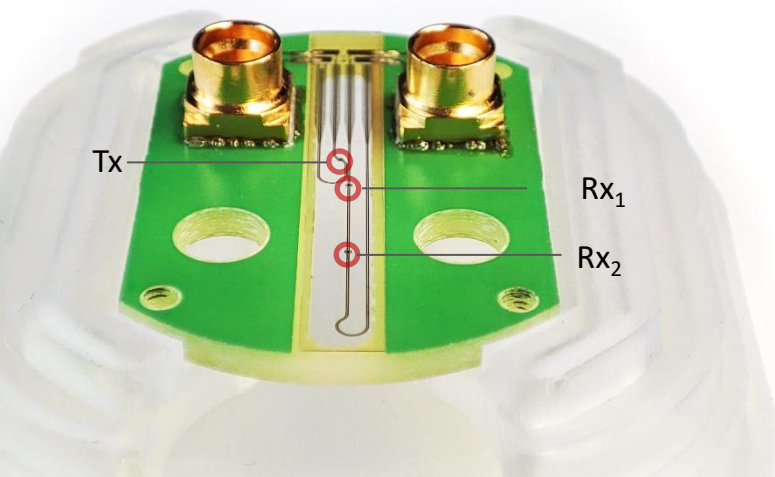

Extra rugged design

TeraSpike XR-option

THE standard design of the **TeraSpike** probe is optimized for highest spatial resolution, lowest field invasiveness and highest sensitivity. This is achieved through the free-standing semiconductor-based cantilever microstructure containing the active field sensor elements. The mechanical robustness of this standard design matches the requirements of long-term application in well controlled and automated systems such as the **TeraCube Scientific** allowing also pointed sample contact.

For applications in rougher environments or where the sample distance is more difficult to control the new XR-design is an excellent choice with drastically further increased mechanical robustness with only moderate loss of spatial resolution and sensitivity.

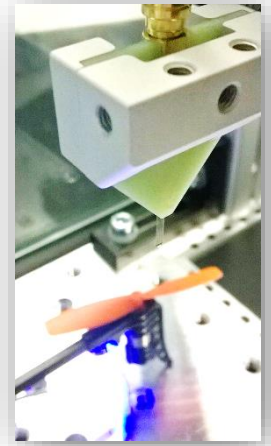

Comparison of cross-section designs: Standard vs. -XR option

Standard

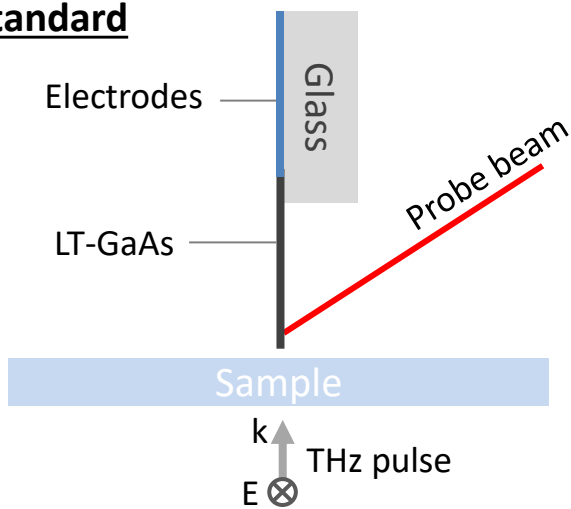

XR

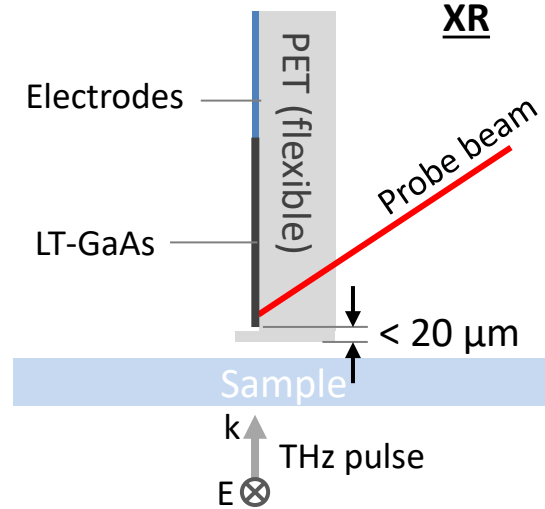

Time- and frequency-domain response: Standard vs. -XR

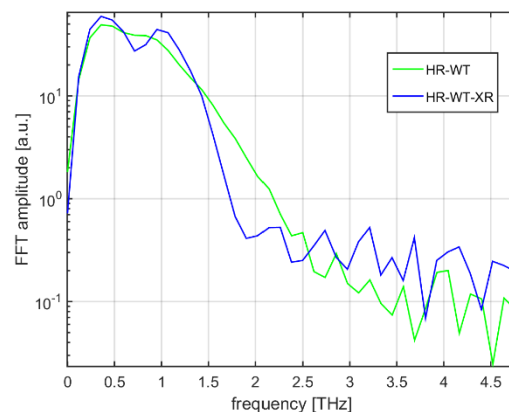
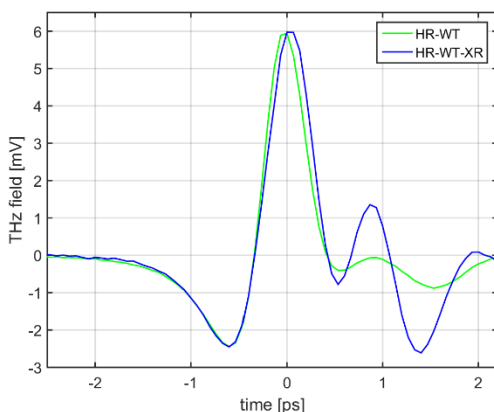

TeraSpike WT-option

TERASPIKE near-field probes are used under different excitation conditions. Some might generate THz modes which are able to propagate along the internal electrodes of the probe. So far, these modes were observed in terms of reflection signals in the recorded time-domain transients.

Protemics has developed a new design called “wavetrapped” which is effectively slowing down and absorbing such probe-internal THz signal transmission.

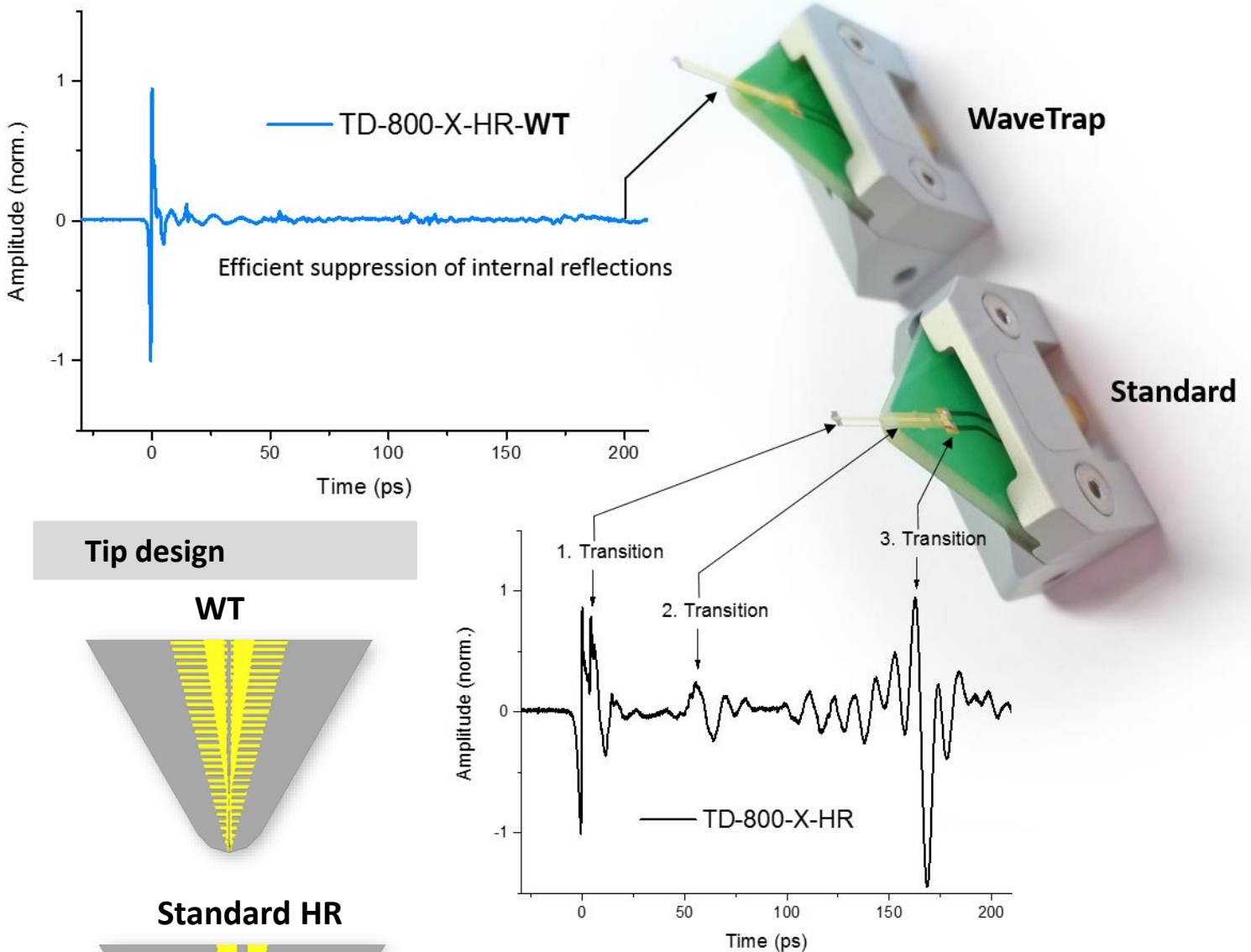

Tip design

WT

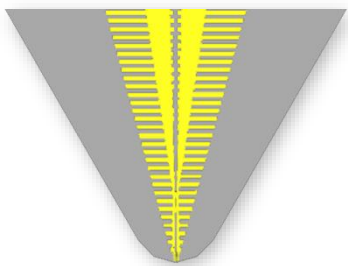

Standard HR

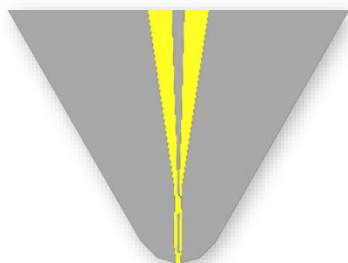

Availability

The WT/XR-options are currently available for the following probes:

- TeraSpike TD-800-X-HR-WT / TD-800-X-HR-WT-XR
- TeraSpike TD-1550-X-HR-WT / TD-1550-X-HR-WT-XR
- TeraSpike TD-800-Z-WT / TD-800-Z-WT-XR
- TeraSpike TD-1550-Y-BF-XR

Bias-free THz pulse generation probe

TeraSpike TD-1550-Y-BF

Technical data

TeraSpike TD-1550-Y	-BF
Pulse rise time	<1 ps (down to 0.4 ps)
Bandwidth*	0.01 .. 2.5 THz
Excitation wavelength	700 .. 1600 nm (<860nm recommended)
Avg. excitation power	0.1 .. 4 mW
Cantilever material	InGaAs (n-type)
Lateral tip radius	8 .. 12 μm
Cantilever length	570 .. 600 μm

*For excitation with optical pulses of 90 fs duration.

#Other designs possible on request.

Product details

- Probe-tip for surface-near bias-free optical generation of pulsed THz signals
- Mount for variable probe orientation and simple removal from the set-up
- Robust probe storage box
- Test certificate & manual
- Patent pending DE 10 2013 020 216.7

Accessories

- Probe-tip dummy structure
- Mounting & focusing units

Tip design (standard)

$R = 10 \mu\text{m}$

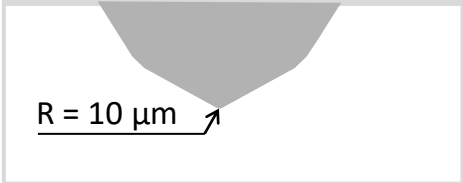

Set-up example: Time-domain reflectometry (TDR)

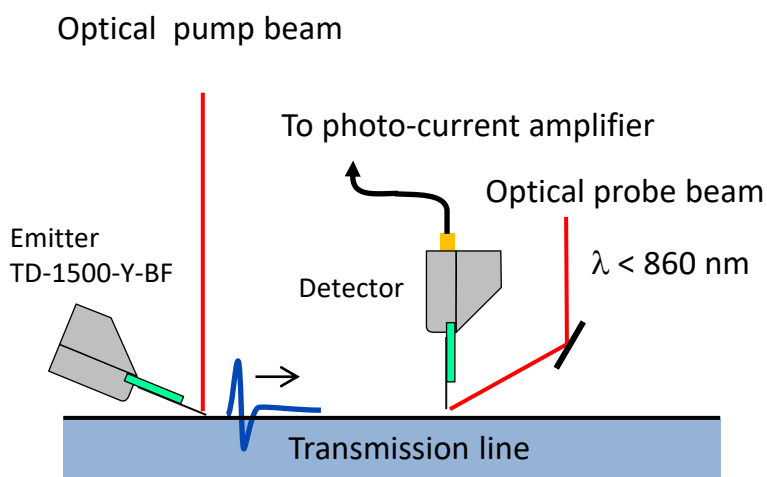

Emitter scheme

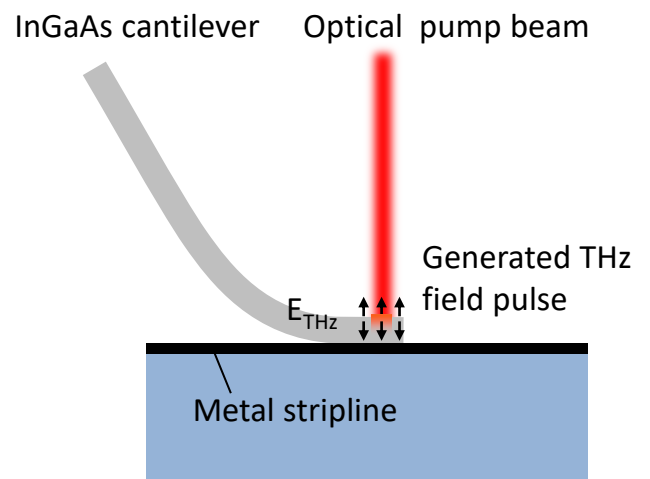

Measurement example using TD-1550-Y-BF:

THz TDR measurement

Time-domain measurement data

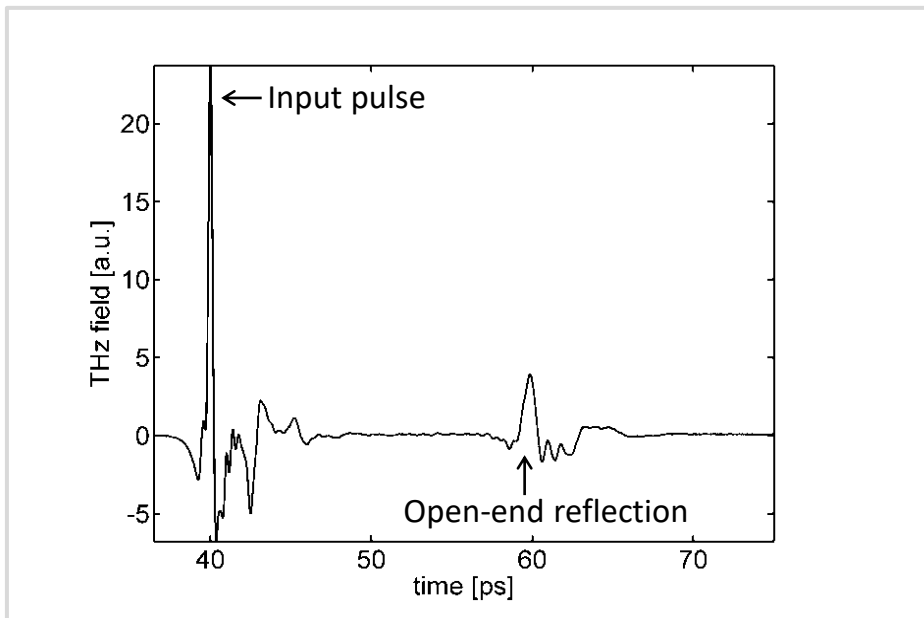

Sample data:

Thin-film microstrip line

- $Z_0 = 110 \Omega$
- $w = 35 \mu\text{m}$
- $h = 57 \mu\text{m}$

Cross-section:

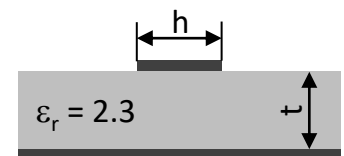

Frequency-domain measurement data

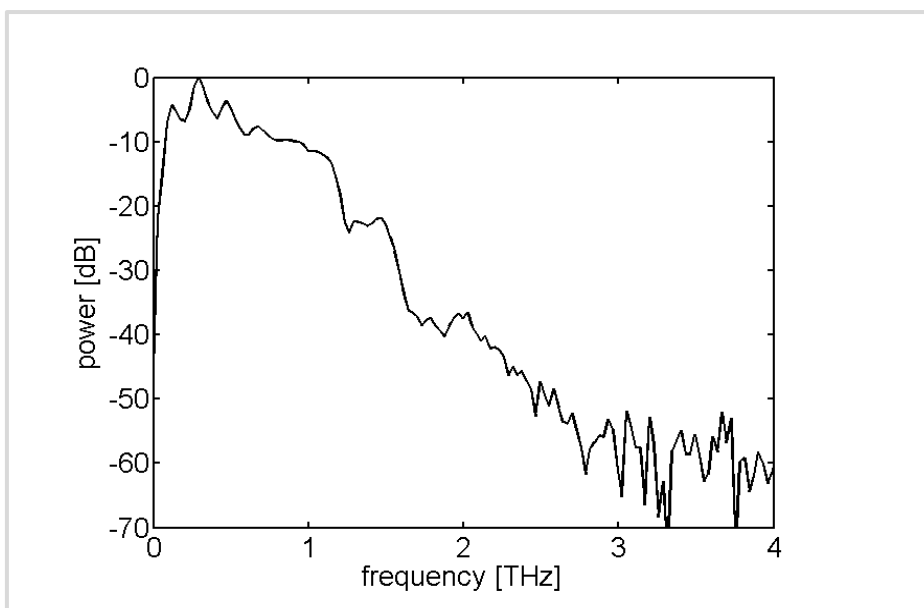

Set-up:

Applied Laser:

- Wavelength: 780 nm
- Pulse length: 90 fs
- Repetition rate: 100 MHz

Emitter:

- TeraSpike TD-1500-Y-BF
- Optical power: 4 mW

Detector:

- TeraSpike TD-800-X-HRS
- Amplification: 10^8 V/A
- Optical power: 3 mW



THz microprobe series

TeraSpike

Schematic

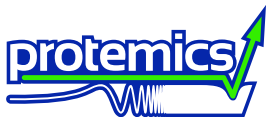
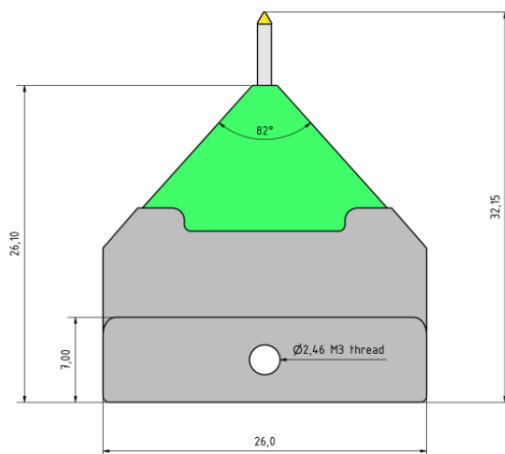
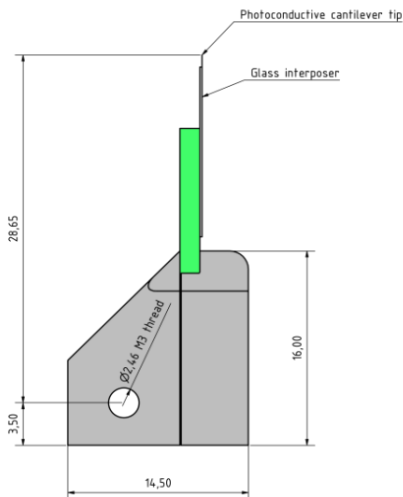
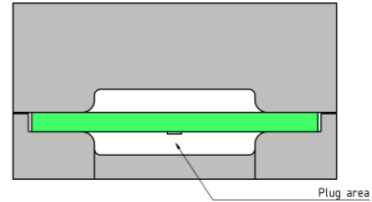
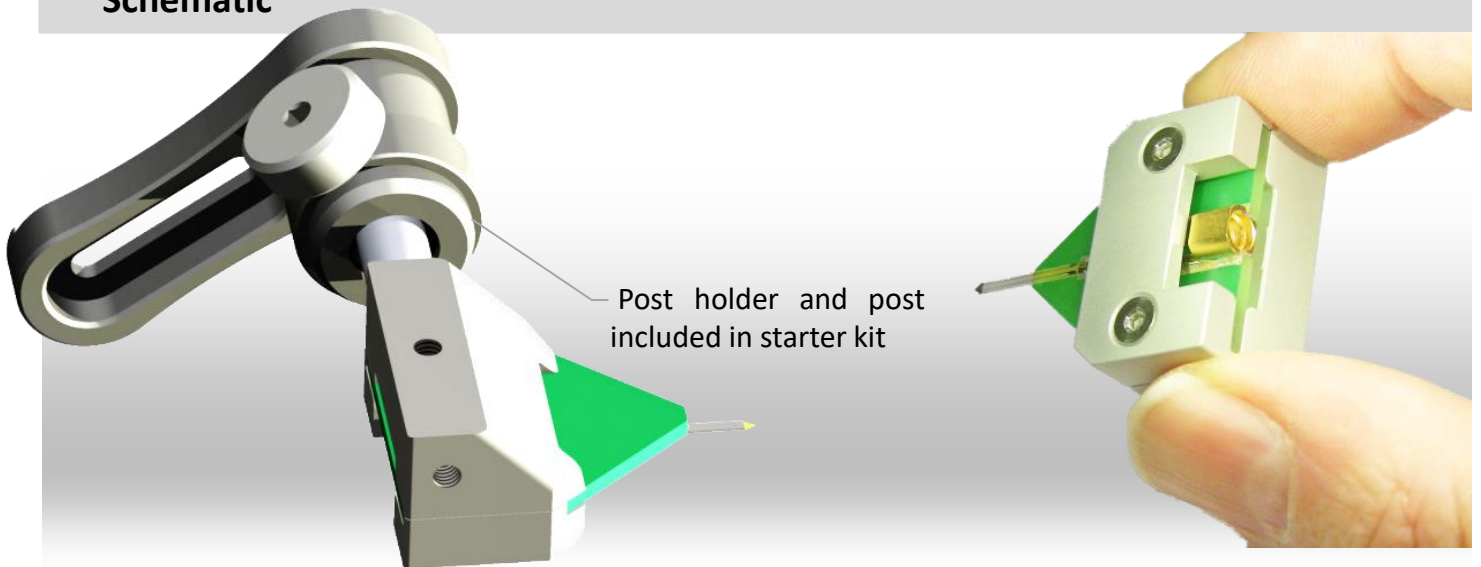

Protemics GmbH
Otto-Blumenthal-Str. 25
52074 Aachen
Germany

www.protemics.com
info@protemics.com
Phone: +49 241 8867 140
Fax: +49 241 8867 560

TeraSpike Connection Cable

TS Cable



Technical data

TS Cable	LXXX-S/R1-CXXX-M/F2-S/R2
RF cable type	RG178
Impedance	50 Ω
Nominal capacitance	96.46 [pF/m]
Length	(typ. 30 .. 100 cm), (LXXX)
Connector 1	SMP, Female
Connector 1 angle	Straight (S1) or right angle (R1)
Connector 2	SMP, SMA or BNC, (CXXX)
Connector 2 gender	Male (M2) or female (F2)
Connector 2 angle	Straight (S2) or right angle (R2)

Product details

- Gold plated brass contact
- MIL-STD-348A
- Highly flexible
- Min. bend radius: 10 mm
- Operating temp. range: -55°C .. 150 °C
- Heat-shrink connector claddings

Order configuration example

TS Cable **L080-R1-CSMA-M2-S2**

Connector 2 angle: Straight

Connector 2 gender: Male

Connector 2 type: SMA

Connector 1 angle: Right angle

Cable length: 80 cm

Accessories

- SMA-to-BNC adapter

Bias-free Terahertz emitter

TeraBlast

Background

THE new bias-free Terahertz emitter series TeraBlast from Protemics are optically pumped THz sources which can be used with a wide range of femtosecond laser sources (such as low power oscillators or amplified lasers with wavelengths in the range of 700..1600 nm).

They are ideally suited and tested for near-field imaging applications including TeraSpike micro-probe operation. The TeraBlast is also a great emitter for classic far-field spectroscopy and other THz applications.

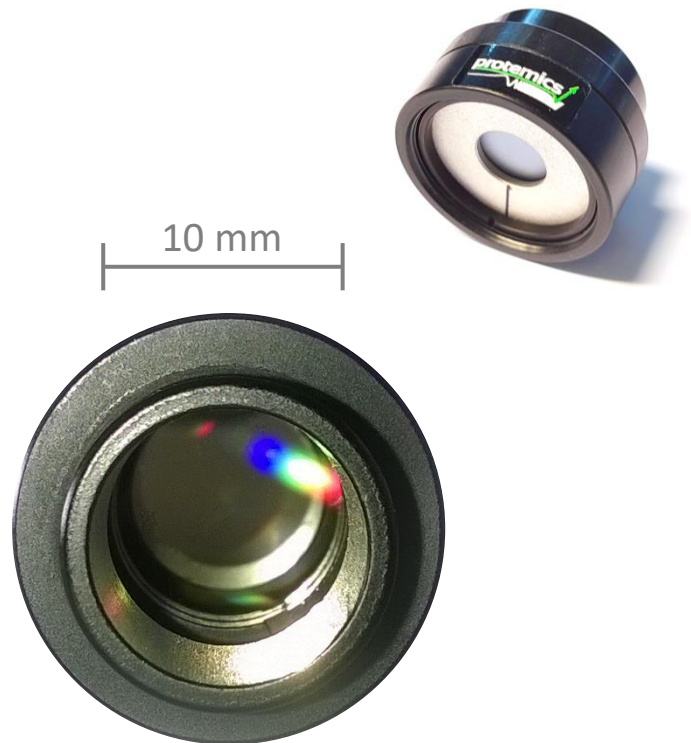

Technical data

TeraBlast TD-1550-L-165	
Excitation wavelength range	700 .. 1600 nm
Typ. average excitation power range	5 mW .. 1000 mW
Average THz emission power	> 2.5 μ W ^(a)
Active area diameter	10 mm ^(b)
Adapter dimension (Outer diameter)	1/2 inch

^(a) Measured with pyroelectric detector (Spectrum Detector Inc. SPI-D-62-THz) for 370 mW optical pump power.

^(b) Larger active areas possible. Please request!

Key benefits

- Recommended THz source for TeraSpike microprobe operation
- High emission power
- Patent pending design (DE102012010926 A1)
- Virtually no alignment or focusing effort
- Can be used as a point source or array emitter
- Linearly polarized emission
- Extremely robust due to bias-free operation
- No device failure on local short-cut defects
- No dark current
- No parasitic off-set signal generation in lock-in detection schemes

Protemics GmbH
 Otto-Blumenthal-Str. 25
 52074 Aachen
 Germany

www.protemics.com
 info@protemics.com
 Phone: +49 241 8867 140
 Fax: +49 241 8867 560

Bias-free Terahertz emitter

TeraBlast

Emitter scheme

Dimensions

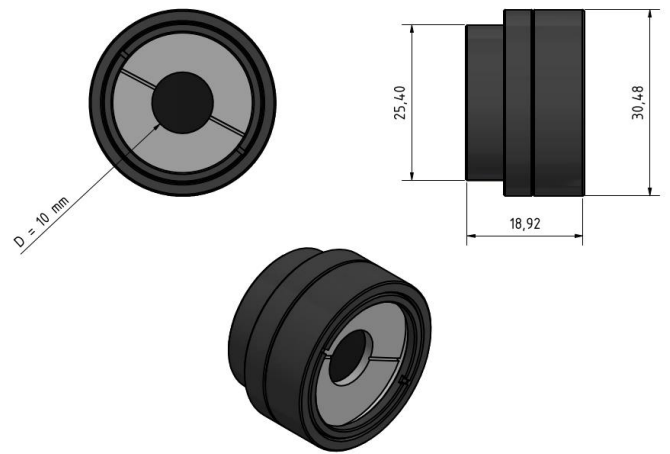
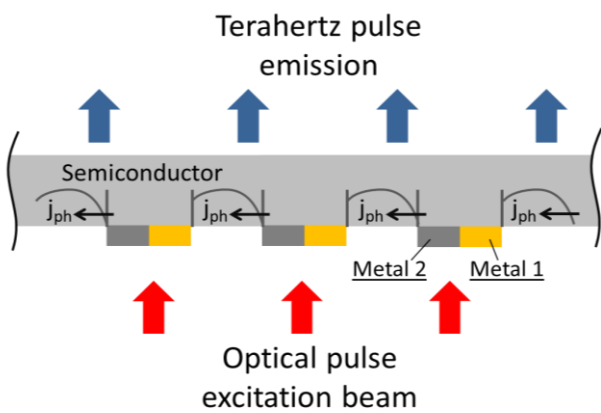

Exemplary measurement data

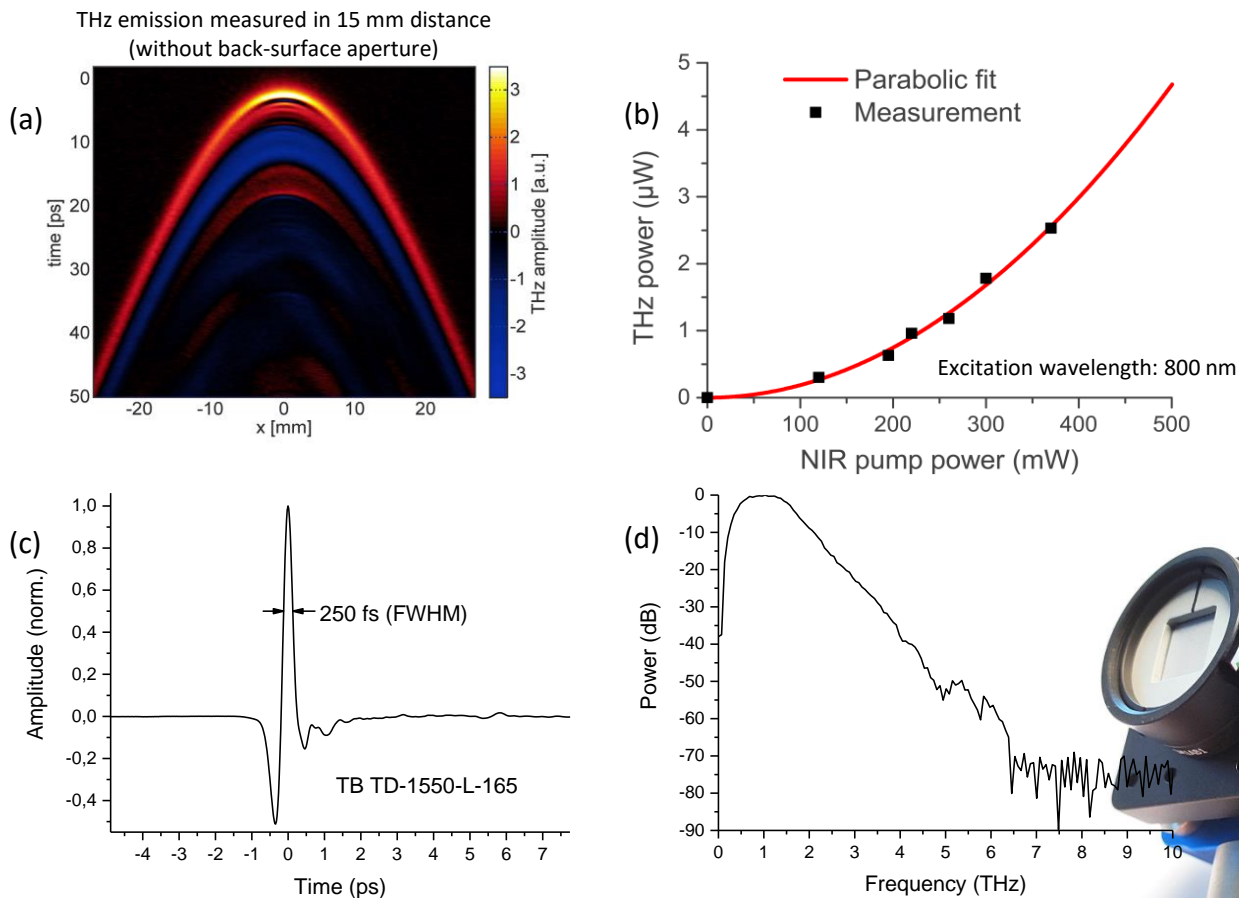

(a) Measured with TeraSpike TD-800-X-HRS, (b) Measured with SPI-D-62-THz from Spectrum Detector Inc. (c) & (d) Far-field transmission through atmosphere measured with a femtosecond laser from Laser Quantum („taccor”) and electrooptic detection in a 400- μ m-thick GaP crystal using ASOPS based time-domain spectroscopy.

IR-to-NIR light conversion modul

SHG-Unit

THE new SHG-Unit from Protemics is an easy to operate and very efficient solution to convert IR light from cost-efficient femtosecond fiber-lasers into NIR light for the high-efficiency excitation of our LT-GaAs-based TeraSpike microprobes and TeraBlast emitters.



Schematic

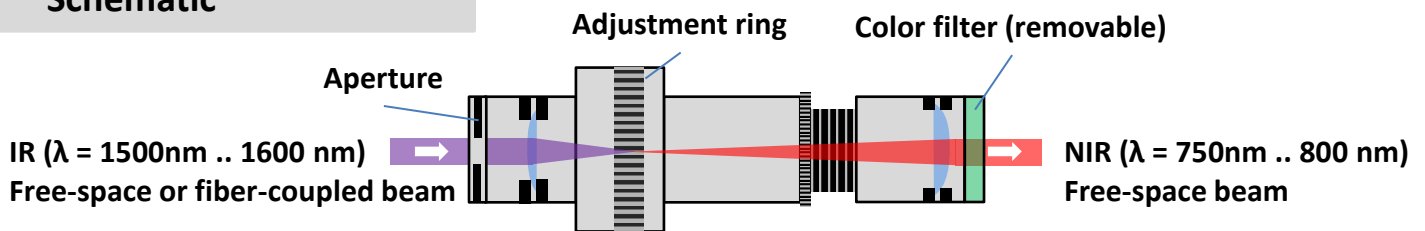

Technical data

SHG-Unit TD-1550-NLO (-FS/-FC)	
Input wavelength range	1500 .. 1600 nm
Typ. average input power range	30 mW .. 200 mW
Typ. power conversion efficiency ^(a)	10 .. 50 % ^(a)
Min. aperture diameter	ca. 6 mm
Dimensions (l x d)	120 mm x 45 mm

Key benefits

- Recommended for TeraSpike microprobe operation with IR femtosecond lasers
- High power conversion efficiency
- Passive and robust design
- Short warm-up time: (10-15 min)
- Can be configured for free-space (-FS) or fiber-coupled input beams (-FC)
- Easy to use and integrate

Configuration example

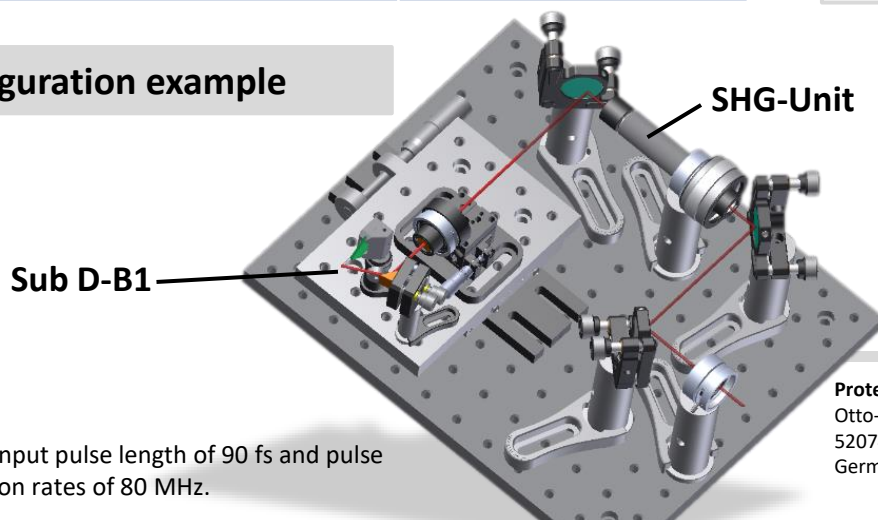

^(a) For an input pulse length of 90 fs and pulse repetition rates of 80 MHz.

Protemics GmbH
Otto-Blumenthal-Str. 25
52074 Aachen
Germany

www.protemics.com
info@protemics.com
Phone: +49 241 8867 140
Fax: +49 241 8867 560

Terahertz Test Target

P-TTT-2-1200

THE test target P-TTT-2-1200 has been specially developed for the characterization of Terahertz imaging systems. Featuring structures and areas from 2 μm up to 8 mm of lateral size it is suited for standard diffraction-limited systems as well as near-field imaging systems with sub-wavelength resolution.

Schematic

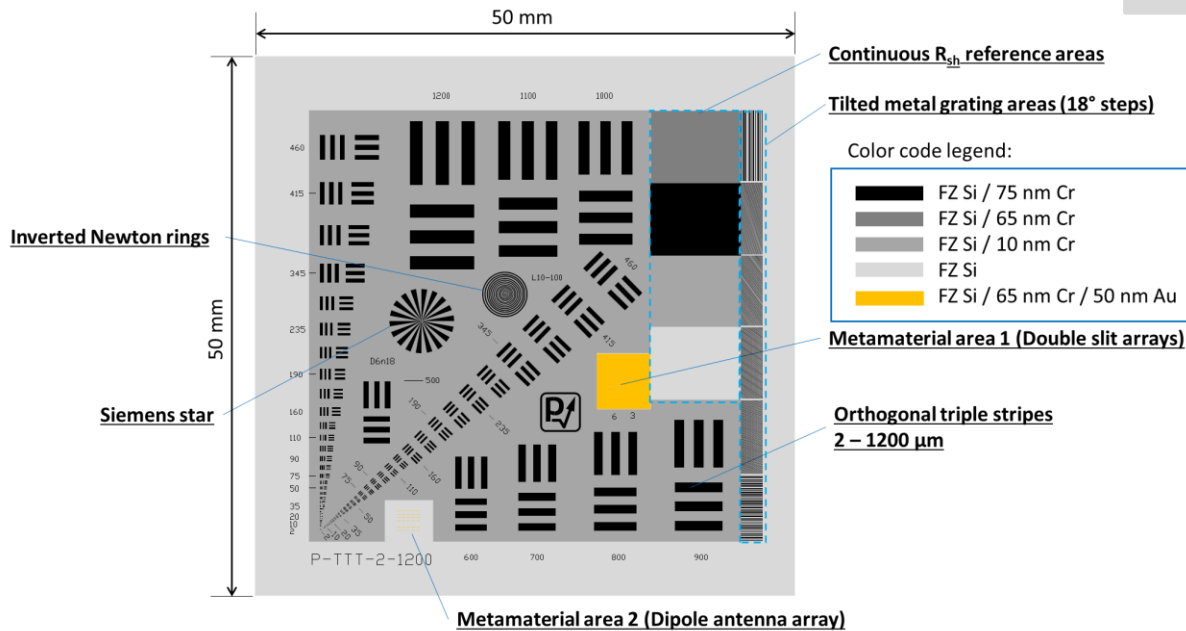

Technical data

P-TTT-2-1200	
Substrate material	High-resistivity FZ silicon, 2-side polished
Substrate Resistivity	> 10 kOhm cm
Target overall size	2" x 2" (50 mm x 50 mm)
Substrate thickness	525 μm
Coating material	Cr, Au
Coating thickness	Cr: 10 nm, 65 nm and 75 nm Au: 50 nm
Orthogonal pairs of triple stripes	2 – 1200 μm wide lines & spaces 45° rotated for 2 - 460 μm wide line & spaces
Siemens star	6 mm diameter, 18 elements
Inverted Newton rings	5.6 mm max. diameter, 10–500 μm ring widths
Continuous R_{sh} Reference areas	6.7 mm x 8.3 mm
Tilted metal grating areas	2 mm x 6.7 mm, 0°, 18°, 36°, 54°, 72°, 90°
Bow-tie array metamaterial	300 μm length, 5 μm gap
Double slit array metamaterial	3 μm and 6 μm slit width and spaces

Key benefits

- Optimized for THz far- and near-field imaging system evaluation with semitransparent thin-film conductor structures
- Applicable for sub-wavelength **and** standard diffraction-limited resolution (2 μm – 1.2 mm)
- Includes metamaterial structures with local field enhancement specially useful for near-field system evaluation
- Also applicable for contrast evaluation and referencing of sheet resistance imaging systems

Advanced low-noise current amplifier

TeraSpike Companion



THE new TeraSpike Companion is the first commercially available low-noise amplifier specially designed and optimized for THz time-domain spectroscopy applications based on photoconductive detectors and emitters - including of course the full line of Protemics TeraSpike (TS) microprobes. In contrast to conventional current amplifiers, the TS Companion offers important additional functions that are typically required for THz-TDS-related tasks, including e.g. Connections for Tx and Rx devices, an optical alignment mode, switchable bias function for all inputs as well as a fully electronic control for system integration. A fine selection of amplification in steps of a fifth of a decade is included for optimal utilization of the maximum possible signal-to-noise ratio in any THz system. As required for operation with fast-scanning THz TDS modules (e.g. TeraFlash Pro, Toptica), it also offers a comfortable bandwidth reserve that ensures unadulterated THz signal detection up to the highest amplification range.

Description

Key features:

- Two input channels
- Optical alignment & THz detection mode
- Gain variable in 0.2×10^x steps
- 40 kHz bandwidth for every gain
- Local and remote control options

Applications e.g.:

- Protemics near-field probe operation including transceiver, emitter or detector probes
- General Terahertz photo-conductive antenna operation

Model	LNA-40k-8E8
Trans-impedance gain [V/A]*	$1 \times 10^6 \dots 8 \times 10^8$, switchable in steps of 0.2×10^x
-3-dB-Bandwidth [kHz]*	40, for all gain settings. Switchable to 0.4
Amplifier output voltage [V]	± 12
Output impedance	Open
Max. output current [mA]	± 40
External bias supply for THz device inputs	± 12 V, max. 120 mA
Indicator LED	On: Overload, Off: Normal operation
Power supply voltage	± 5 V... ± 14 V (max.), ± 12 V (recommended)
Power supply current	Typ. ± 30 mA
Weight [g]	120
Operating temperature range	0 .. 70 °C

*Can be customized on request. For further information please contact us on info@protemics.com

Designed for THz applications

LNA-40k-8E8

Block diagram

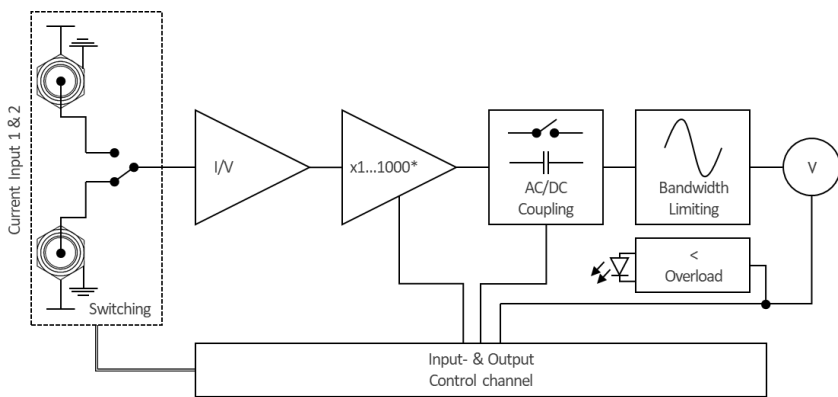

Dimensions

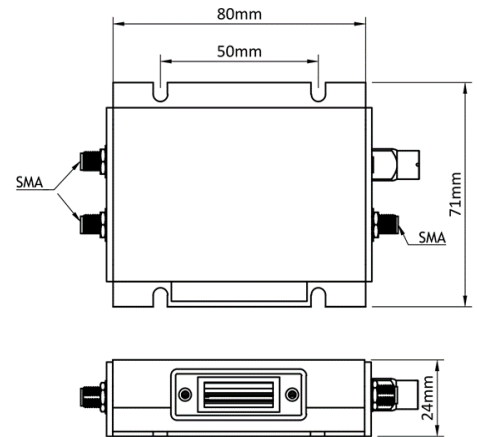

Interface description

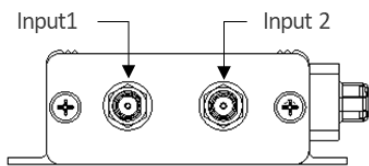

Input side view

Input1: SMA, isolated, jack female
 Input2: SMA, isolated, jack female
 Detector bias output: shield of the input1 SMA & input2 SMA

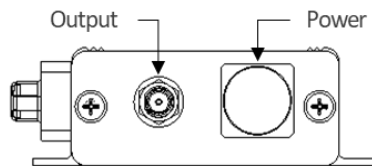

Output side view

Output: SMA, jack female

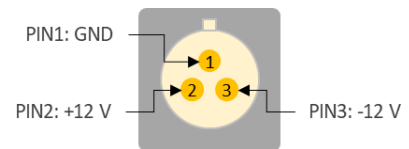

Power supply connector

Socket: Lemo series 0B, 3-pin fixed socket
 Plug: Matching parts
 FGG.0B.303.CLAD52
 Pin 1: GND Pin 2: +12 V Pin 3: -12 V

Gain spectrum

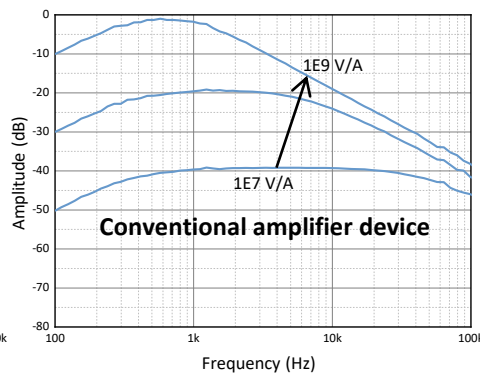
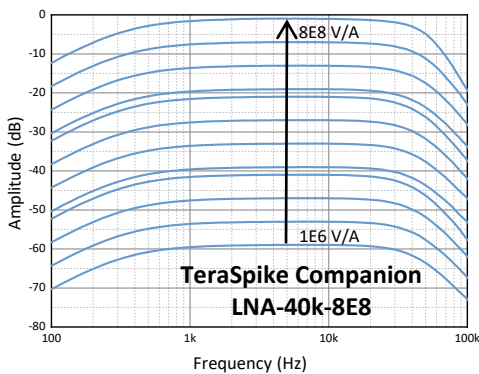

THz TDS application*

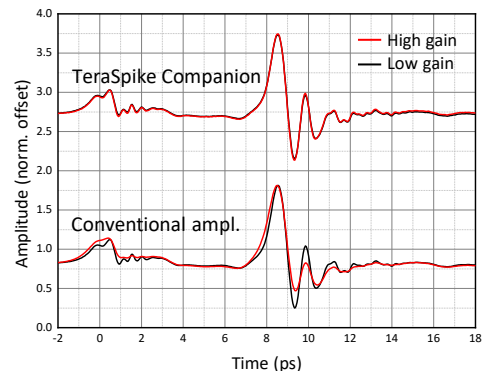

* Measured with TeraSpike TD-800-TSR-TT.75-PCA-PCS-10-50

Integration components

Sub-system modules

Sub-system D-B1-TR

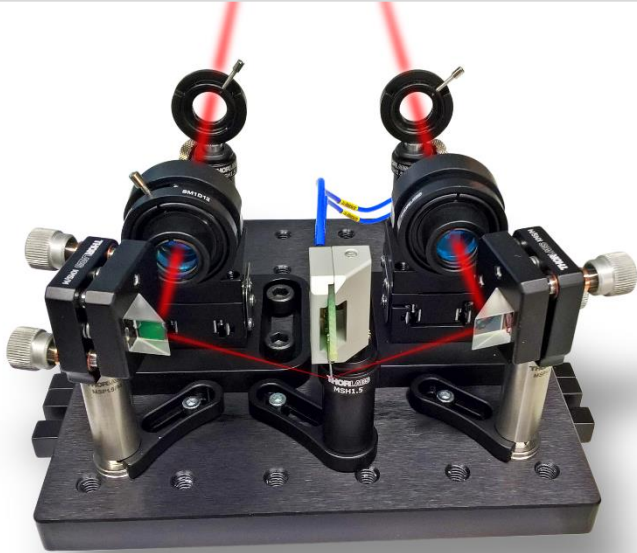

Description

Mini-board set-up with prealigned opto-mechanical components for the transceiver probe TeraSpike TD-800-TR.5.

Functions:

- Supports two optical beams for emitter and detector switch excitation
- Probe-tip mounts
- Manual beam-to-tip focusing
- Manual beam-to-tip alignment
- Manual probe-tip height variation

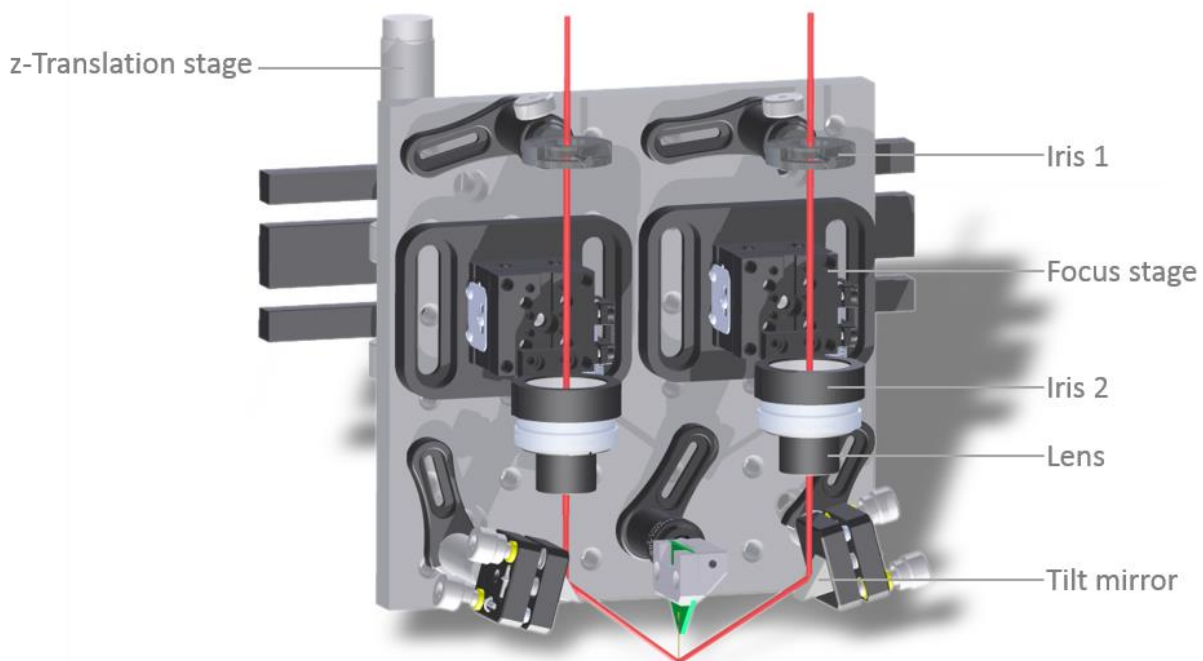

Integration components

Sub-system modules

Sub-system D-B1

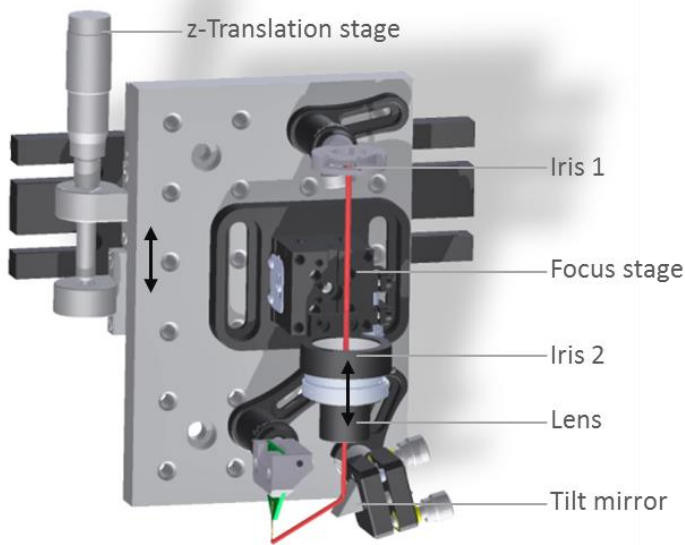

Description

Mini-board set-up with pre-aligned opto-mechanical components for the system integration of TeraSpike microprobes.

Functions:

- Microprobe mount
- Manual beam-to- microprobe focusing
- Manual beam-to- microprobe alignment
- Manual microprobe height variation

Sub-system D-B2

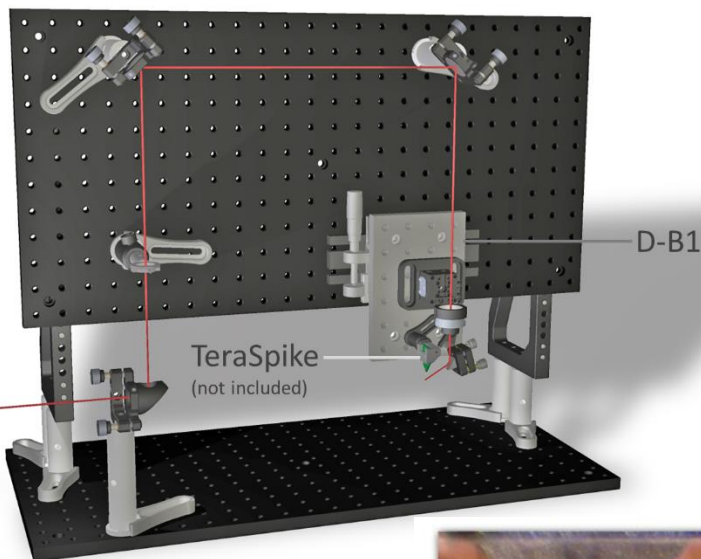

Description

Multi-board set-up with pre-aligned opto-mechanical components.

Functions:

- Motherboard including sub-system D-B1 in customized height
- Assembly brackets
- 2 alignment apertures
- 2 tilt mirrors
- Extendable with CCD camera and distance sensor

Option (-CAM):

- Integrated CCD microscope camera system with variable illumination for monitoring of probe-tip to sample surface approximation and sample positioning

Exemplary CCD camera image of a TeraSpike microprobe tip above sample microstructure.

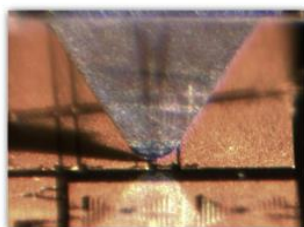

Terahertz microprobing Solutions

References



BOSCH



ECN

**RWTHAACHEN
UNIVERSITY**



Applications

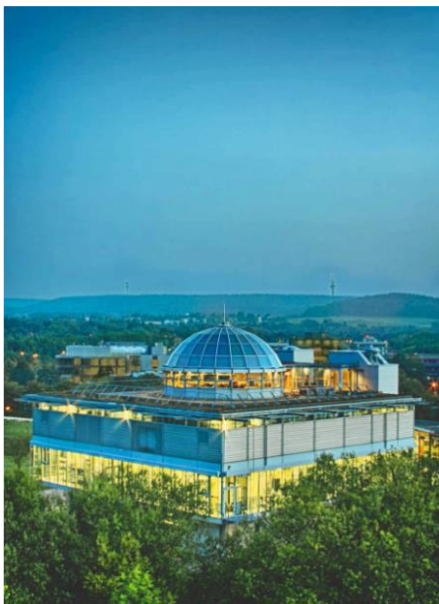

- Non-destructive testing ■
- Terahertz research ■
- Near-field analytics ■
- Transparent conductors ■
- Flexible electronics ■
- Graphene ■
- Wafer inspection ■
- Thin-film analysis ■
- Metamaterials ■
- Solar cell inspection ■
- Terahertz device analysis ■
- Fault location ■
- Time-domain reflectometry ■
- Terahertz waveguide analysis ■
- Marker-free biosensing ■
- Plasmonics ■

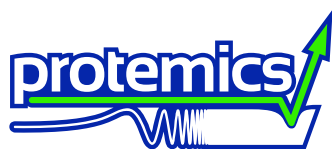

Protemics GmbH
Otto-Blumenthal-Str. 25
D-52074 Aachen
Germany

www.protemics.com
info@protemics.com
Phone: +49 241 8867 140
Fax: +49 241 8867 560

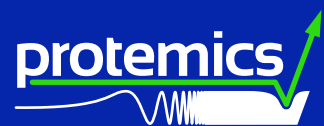
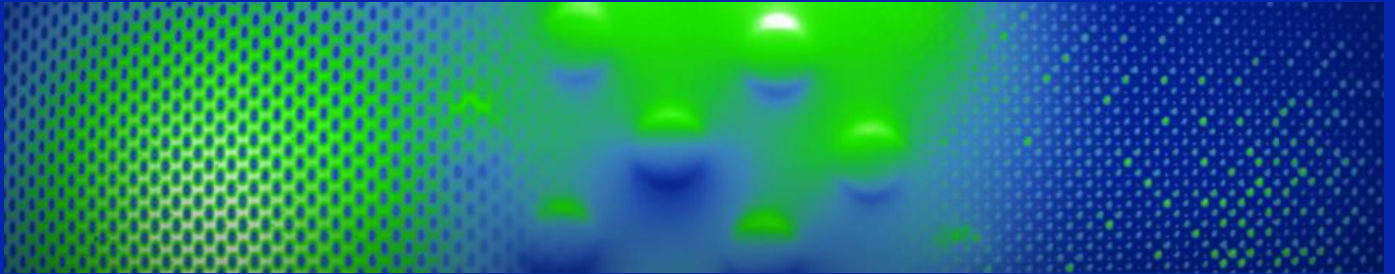

TERAHERTZ MICROPROBING SOLUTIONS

