

λ Range: 190 nm - 16 μm*
Smallest pixel: 3.2 x 3.2 μm*
Smallest Beam: 32 μm**
Imaged Areas*: 6.3 x 4.8 to 20 x 15 mm
 * Camera/ Sensor dependent
 ** Direct measurement, see p. 3

Features

- ◇ **NEW WinCamD-LCM 1" CMOS array with 5.5 μm², 1, 2, & 4 MPixel Formats available**
- ◇ **Synchronous Shutter = No Comet Tailing**
- ◇ **Update Rate to 50 Hz with new SuperSpeed USB 3.0 interface** (LCM series is USB 3.0 all others USB 2.0)
- ◇ **New stackable MagND Filters** (LCM series only)
- ◇ **Port-powered**, flexible 3 m cable, **no external power supply required.**
- ◇ WinCamD-LCM Compact **1.8 x 1.8 " x 0.8"** (20 mm) fits tight beam trains
- ◇ **HyperCal™** Dynamic Noise and Baseline Correction software (Pat. Pending)
- ◇ **CTE™** Comet Tail Elimination for λ > 900 nm (CCD based cameras), (Pat. Pending)
- ◇ Digital CCD/CMOS cameras with on-chip 12/14/16-bit ADC (camera dependent)
- ◇ 4 MB image buffer & on-board microprocessor
- ◇ Window-free sensors standard for no fringing
- ◇ 25,000:1 electronic auto-shutter, 40 μs to 1000 ms
- ◇ 1,000:1 SNR (30/60 dB Optical/Electrical)
- ◇ Pulsed laser auto-trigger & synchronization
- ◇ Isolated Pulse Triggering and Parallel capture on multiple cameras
- ◇ Field-replaceable image sensors
- ◇ Large area TaperCamD options to 20 x 15 mm (p.7)
- ◇ X-Ray, UV, 1310 nm (p.8), 1475-1680 nm (p.10) & 2-16 μm
- ◇ Windows 8, 7, Vista and XP, 32 and 64 bit. PC or Mac-Intel using Parallels or BootCamp



WinCamD-LCM Series Camera
 With **new** MagND Filter
 Shown actual size
 1.8 x 1.8 x 0.8"



BladeCam Series Camera
 1.8 x 1.8 x .065"

Applications

- ◇ **CW & Pulsed** laser profiling
- ◇ Field servicing of lasers and laser-based systems
- ◇ Optical assembly & instrument alignment
- ◇ Beam wander & logging
- ◇ **M²** Measurements



WinCamD Series Camera
 2.40 x 2.65 x 1.12" (x0.9" without filter)
 61 x 67 x 28 mm

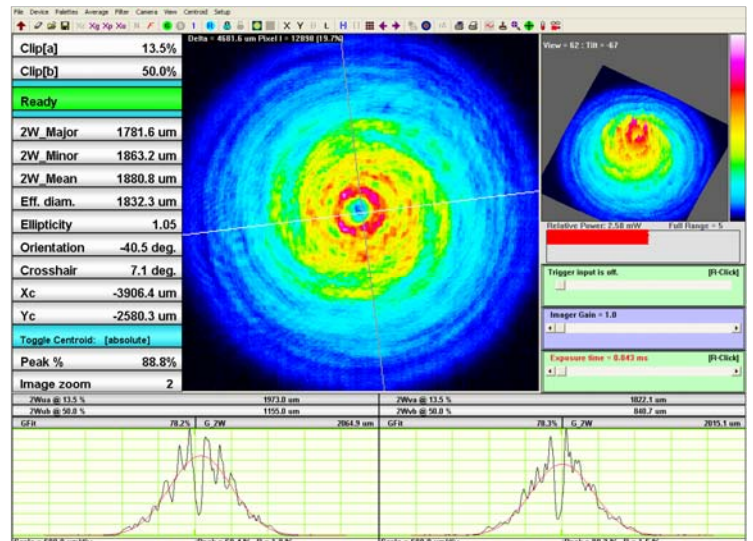

New - More Powerful Beam Analysis Software

Log profile displays, no averaging.

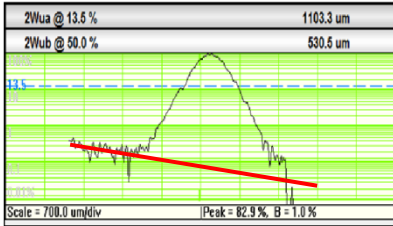

Without **HyperCal™**
0.3% noise + baseline tilt

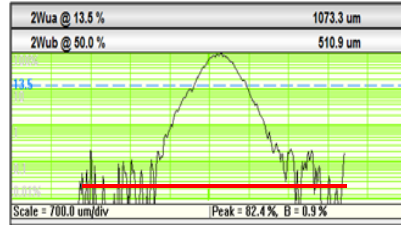

With **HyperCal™**
Noise <0.1% & flat baseline

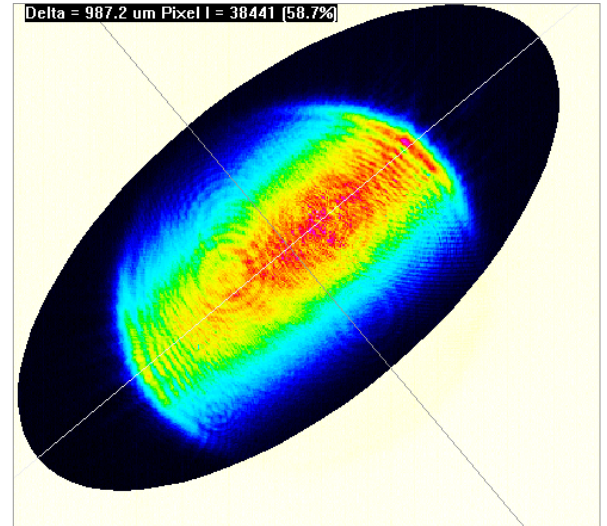

Auto-Inclusion Region on an Elliptical Beam
Automatically isolates the appropriate analysis region.
With user overrides and multi-beam features.

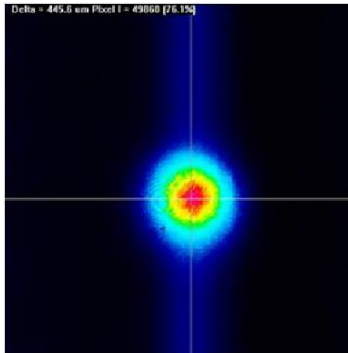

With 1064 nm Comet Tail
CTE™ Comet Tail Elimination @ λ > 900 nm

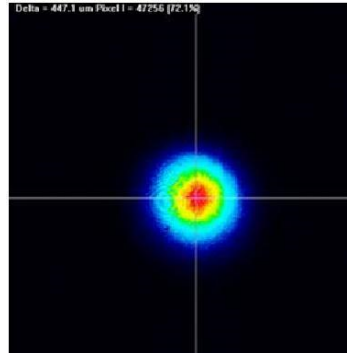

With **CTE™**

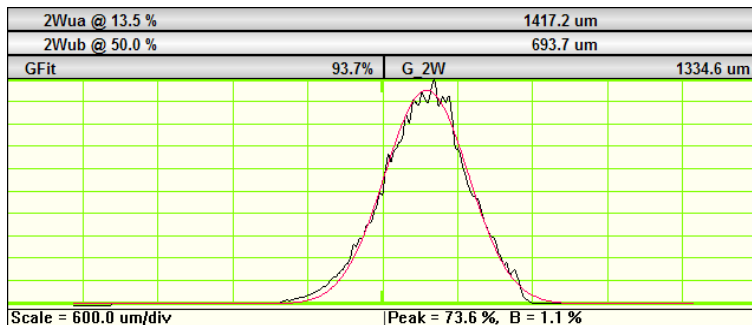

Standard Linear Profile with Gaussian Fit.

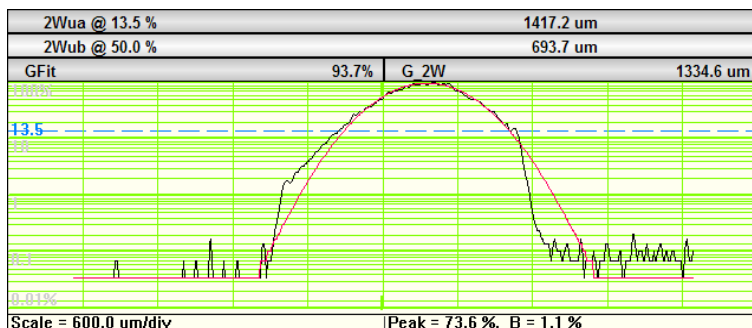

Logarithmic Profile shows more detail near baseline

The same profile with Averaging & Log 40 dB display reveals structure in the wings of the beam at levels below 1%

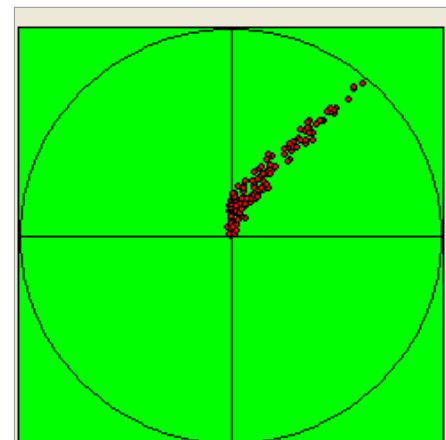

Scale radius = 30 um
Samples taken = 146
Max deviation = 28.7 um
Last deviation = 18.9 um
Mean = 9.9 um RMS = 12.20 um (12.24)

Time interval = minimum

Samples to be recorded = 8192

Clear	Replay	To Clipboard
Normalize	Replay Fast	Save as bitmap
To Excel	Sequence Off	Export to Paint

Beam Wander on a drifting Laser

Up to 8192 samples at a User Set interval.
Mean, RMS and Max. deviation. Replay Fast or Slow. Export to Excel, Paint, Bitmap or Clipboard.

DataRay Innovation - The company that brought you the *first* Windows-based CCD beam profiler, the *first* Camera for confined spaces, the *first* software slider exposure and electronic auto-shutter, the *first* standard window-free CCD for no fringing, the *first* auto-orientation on the ellipse & the *first* USB 2.0 beam profiling camera ... has done it again now with our new USB 3.0 compact 1" format cameras.

Compact WinCamD cameras: Fully featured cameras small enough to fit in your shirt pocket, or to fit in a space 0.65" thick (BladeCam).

Features:

- ◇ Digital serial link for EMI immunity
- ◇ XY profiles and centroids
- ◇ Linear and logarithmic displays
- ◇ Gaussian and Top Hat least squares fits
- ◇ Ellipse Angle, Major, Minor, Mean Diameters
- ◇ Background capture and subtraction
- ◇ Image & Intensity Zoom
- ◇ Linear and area filters
- ◇ Image Averaging, 1 to continuous
- ◇ Compact design 0.65" Probe style for tight applications

WinCamD-CCD & CMOS

Sensor Specifications:

WinCamD™	-LCM4	-LCM2	-LCM1	-UCD12	-UCD15	-UCD23	-HR***	-XHR***	-FIR2-16-HR
Pixel Count & H x V:	4 M Pixel 2048 x 2048	2 M Pixel 1600 x 1200	1 M Pixel 1024 x 1024	1.4 M Pixel 1360 x 1024	1.9 M Pixel 1600 x 1200	1.4 M Pixel 1360 x 1024	1.3 M Pixel 1280 x 1024	3.1 M Pixel 2048 x 1536	308 k Pixel 480 x 640
Sensor image area (mm):	11.3 x 11.3	8.8 x 6.6	11.3 x 11.3	6.3 x 4.8	7.1 x 5.4	8.8 x 6.6	6.6 x 5.3	6.5 x 4.9	10.9 x 8.2
Pixel dimension (µm):	5.5 x 5.5	5.5 x 5.5	11 x 11	4.65 x 4.65	4.4 x 4.4	6.45 x 6.45	5.2 x 5.2	3.2 x 3.2	17 x 17
Min. beam (10 pixels):	55 µm	55 µm	110 µm	~47 µm	~44 µm	~65 µm	~52 µm	~32 µm	~170 µm
Shutter type:	Synchronous	Synchronous	Synchronous	Synchronous	Synchronous	Synchronous	Rolling	Rolling	Sampled Array
Max. full frame rate:	≥15 Hz	≥30 Hz	≥30 Hz	~5-10 Hz	~5-10 Hz	~5-10 Hz	~5-10 Hz	~5-10 Hz	9 Hz
Max. 'every pulse' PRR:	10 Hz	≥30 Hz	≥30 Hz	~5-10 Hz	~5-10 Hz	~5-10 Hz	NA	NA	NA
Single pulse capture PRR:	18 Hz	18 Hz	18 Hz	20 kHz	20 kHz	20 kHz	20 kHz	20 kHz	NA
Signal to RMS Noise:	1,000:1	1,000:1	1,000:1	1,000:1	1,000:1	1,000:1	1,000:1	1,000:1	>100:1
Opt./Elec.* dB:	60 dB	60 dB	60 dB	30/60* dB	30/60* dB	30/60* dB	30/60* dB	30/60* dB	>20/40* dB
Electronic Shutter Dynamic Range:	63 dB	63 dB	63 dB	44 dB	44 dB	44 dB	44 dB	44 dB	9 dB
ND+Shutter+SNR Dynamic Range**:	113 dB**	113 dB**	113 dB**	113 dB**	113 dB**	113 dB**	113 dB**	113 dB**	Call
	2.10 ¹¹ :1	2.10 ¹¹ :1	2.10 ¹¹ :1	2.10 ¹¹ :1	1.6 ¹¹ :1	2.10 ¹¹ :1	2.10.10 ¹¹ :1	2.10.10 ¹¹ :1	Call
TaperCamD-UCD12 pixel size:	NA	NA	NA	11 x 11 µm	NA	NA	NA	NA	NA
TaperCamD-UCD20-15 Pixel size:	15 x 15	NA	NA	NA	NA	15 x 15 µm	NA	NA	NA
ADC:	12/ 10 bit	12/ 10 bit	12/ 10 bit	14-bit	16-bit	14-bit	10-bit	10-bit	12-bit
Interface:	USB 3.0	USB 3.0	USB 3.0	USB 2.0	USB 2.0	USB 2.0	USB 2.0	USB 2.0	USB 2.0

*OK, we agree that quoting electrical dB for optical SNR is nonsense, but some suppliers do this, so we offer a comparable specification.

** OK, we agree that Dynamic Range that includes removable ND filters is also nonsense, but some suppliers do this, so we offer comparable specification with ND

*** Available in both BladeCam™ and WinCamD™ housings

Common WinCamD/BladeCam Series Specifications: [Specifications are subject to change without notice]

Wavelength: Standard	~350 to 1150 nm
-1310	~350 to 1330 nm. Residual silicon response. 1290 nm long-pass filter and light guard tube provided.
-NIR	~1480 to 1680 nm. NIR to Visible conversion phosphor (Erbium response), 40 µm FWHM Point Spread Function
-FIR-HR	~2 to 16 and 35 µm pixel pitch, 640 x 480 pixels, 10.9 x 8.2 mm (WinCamD-FIR2-16-HR)
-UV	~190 to 1150 nm UV converters with wavelength options down to X-ray. UV resolution to 1µm.
High dynamic range to 113 dB electronic (see notation under chart)**	25,000:1 (44 dB) continuously variable auto electronic shutter, <40 µs to 1.0 s. Additional 10,000:1 ND filter + 5:1 electronic control to give 10 ⁹ :1.
Pulsed lasers	Auto-trigger sync, TTL input trigger, TTL output trigger
Interface	Port Powered USB 2.0 for laptops & desktops. 3 m standard thin cable, 5 m option. USB 3.0 compatible
Multiple Heads:	1 – 8 cameras. Parallel capture, serial read.
ISO 11146	Beam profile Second moment processing
Certification	RoHS, WEEE, CE
Measurable Sources	CW beams, Pulsed sources. CW to 25 kHz with single pulse isolation, user configurable Synchronous, Asynchronous & Variable Delay trigger options. Software programmable trigger input, +ve or -ve edge, 2 kΩ impedance
Measured Beam Powers	See the Saturation Beam Power/Pulse Energy Graph and Notes, below.
Manual Beam Attenuation:	Provided ND 4.0 (10,000:1) C-mount Neutral Density filters. [ND 4.0 at 546 nm, higher in blue, lower in near IR.] Screw stackable ND 0.5, 1, 2, 3, 4, 5 available.
Options:	EAM-2: 4-wheel stepped variable attenuator, 0 to 90 dB CUB and CUB-UV 3 to 10 %, 30 arc minute wedge samplers for high power beams
Measurement Accuracy	0.1 µm processing resolution for interpolated diameters. Absolute accuracy is beam profile dependent – ~1 µm accuracy is frequently achievable. Centroid accuracy is also beam dependent. It can be as good as ±1 µm since it is arithmetically derived from all pixels above the centroid clip level.

Measured & Displayed Profile Parameters

Beam Diameter: Diameter at two user set Clip levels
 Gaussian & Second Moment beam diameters
 Equivalent diameter above a user defined Clip level
 Equivalent Slit and Knife Edge diameters
 Beam Fit: Gaussian & Top Hat profile fit & % fit
 Equivalent Slit profile
 Ellipticity: Major, Minor & Mean diameters. Auto-orientation of axes.
 Centroid Position: Relative and absolute
 Intensity Weighted Centroid and Geometric Center
 Beam Wander Display and Statistics
 Smoothing Filter: Triangular running filter up to 10% FWHM

Displayed Profiles & Plots

X-Y Profiles, 2D, 3D Plots. Zoom to x10
 10, 32, 16,384 or colors or gray scale. Contoured display at 10 and 32 color.

Processing Options

HyperCal™ Real-time electronic baseline correction
CTE™ Comet Tail Elimination
 Image & profile averaging, 1, 5, 10, 20, Continuous
 Background Capture and Subtraction
 User set Capture Block option
 * **.job** files save all WinCamD custom settings for particular test configurations

Pass/Fail display

On-screen, in selectable **Pass/Fail** colors. Ideal for QA & Production.

Log data and statistics

Min., Max., Mean, Standard Deviation. Up to 4096 samples

Relative Power Measurement Fluence

Rolling histogram based on user's initial input. Units of **mW, μJ, dBm, %** or user choice (relative to a reference measurement input) Fluence, within user defined area

Chip depth from front of case /filter ring all ±0.2 mm

LCM Series	5.7 / 10.7 mm (12.05 mm with MagND)
WinCamD-UCD12	8.6 / 13.1 mm
WinCamD-UCD15	5.7/ 10.2 mm
WinCamD-UHR/ XHR	8.5/ 13.0 mm
WinCamD-UCD23	8.0 / 12.5 mm
BladeCam-HR/ XHR	5.0/ 9.5 mm

(current, verify with factory)

Outline and Mounting W x H x D
 See Drawings Below

WinCamD-LCM	1.8 x 1.8 x 0.81" (46 x 46x 20.7 mm)	MagND Filter adds 0.25" (6.35mm) only LCM series
WinCamD-Series	2.65 x 2.4 x 0.9" (67 x 61 x 23/29 mm)	C-mount ND Filter adds 0.2" (5mm)
BladeCam-HR/ XHR	1.8 x 1.8 x 0.45" (46 x 46 x 11.5/16.5 mm)	C-mount ND Filter adds 0.2" (5mm)

Camera Head Weight

WinCamD 155 gm (5.5 oz); BladeCam- 42.5 grams (1.5 oz)

Minimum Computer Requirements:
 PC or Intel-Mac

2 GHz processor or higher running Windows 7/ Vista/XP, 32 or 64-bit; 2 GB RAM; 200 MB Hard Drive space; 1024 x 768 monitor, Standard USB 2.0 hi-power (500 mA) port or USB 3.0 port.

Outline and Mounting (shown actual size)

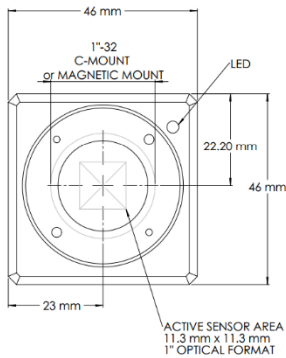

WinCamD-LCM Series
 With new MagND filter

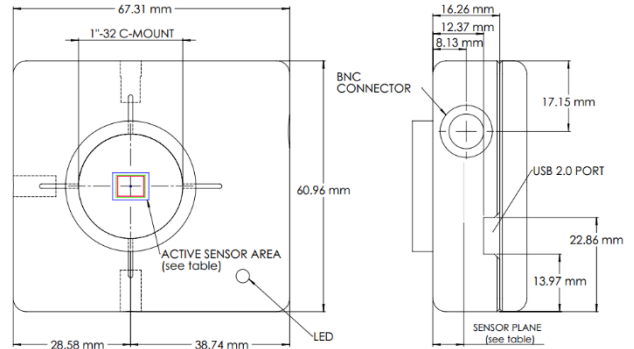
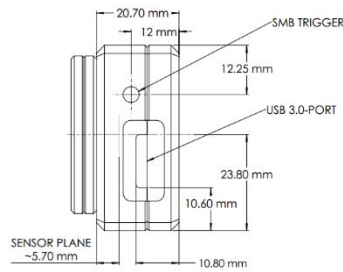

WinCamD series
 with c-mount ND filter

Saturation Beam Power/ Pulse Energy Graphs

These two graphs allow you to simply determine the approximate maximum CW optical power (above) or pulse energy (below) that the standard WinCamD/BladeCam configuration can measure for your beam diameter and wavelength *without additional attenuation*. The **Saturation Limit** assumes:

- The provided ND 4.0 filter in place
- The electronic shutter set at 40 μs , its lowest value
- The ADC gain set at 1, its lowest value
- **The beam onto the ND filter must not exceed 2.5 x (Beam diam. in mm) W, or 10 W total power for large beams.**

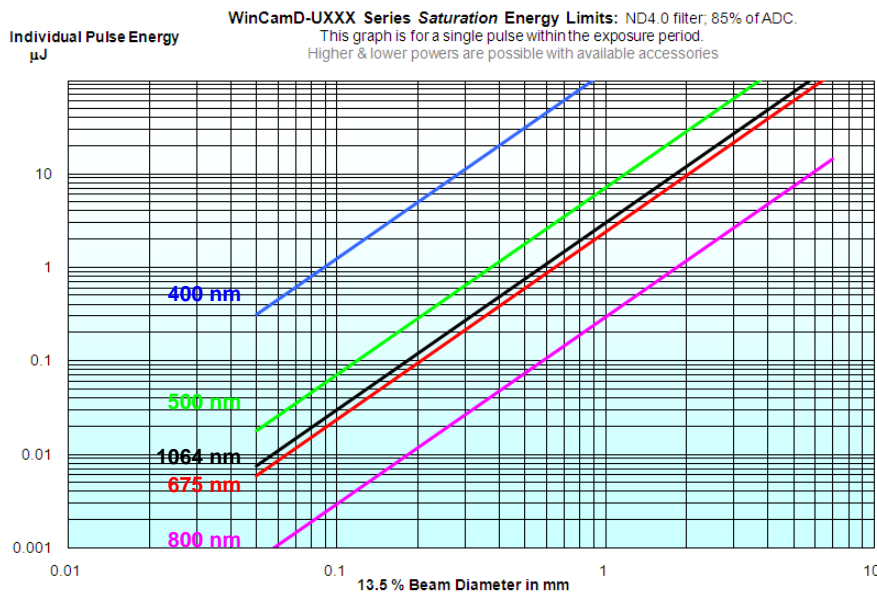
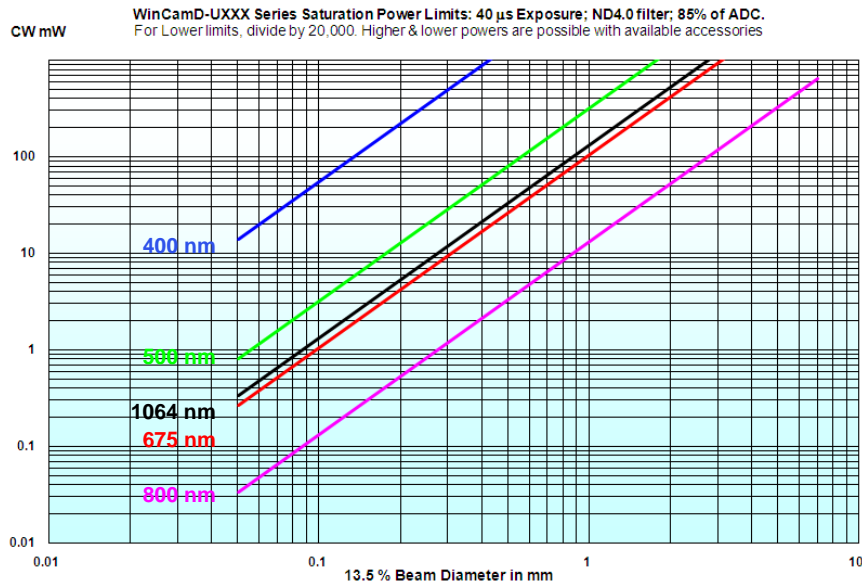

The lower limit in the standard configuration is $\sim 10^{-5}$ x the Saturation Limit.
Use the graph right to estimate for other wavelengths.

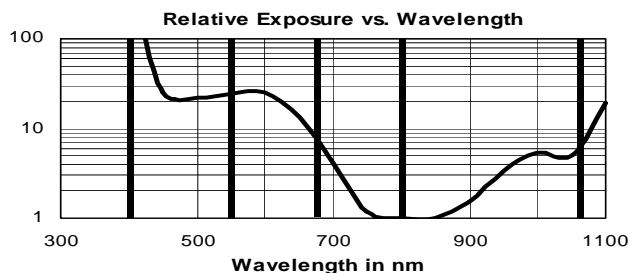

ORDERING INFORMATION

- ◇ 3 Year Warranty ◇ Free Software Upgrades ◇ 30 Day Sale or Return Evaluation PO

A Complete System comprises: USB 3.0/ 2.0 Camera, ND 1, 2 & 4.0 filters, Software, 3 m (10 ft) Cable, User Manual.

Generate the Part Number based upon the component descriptions, and limitations, in the table.

Your CCD or CMOS chip choice does *not* affect the system price, except for the -UCD15 & -UCD23 CCD chips which cost more.

Part Number =	Camera type	+	CCD/CMOS chip	+	Suffix (if required)
	BladeCam		-HR/-XHR		-UV/-1310/-NIR
	WinCamD		-LCM4/-LCM2/-LCM1 -UCD12/-UCD15/ -UCD23/-UHR/-XHR		-UV/-1310/-NIR
	TaperCamD20-15		-UCD23		-1310/-NIR

e.g. **WinCamD-UCD12** is a complete working system with a High Resolution CCD sensor with 4.65 µm pixels.

TaperCamD-1310 is a complete working system with a 14.4 x 10.8 mm FO Taper for 1310 nm.

Part Number Descriptions

WinCamD-LCM4	1" CCD sensor for CW and pulsed, 2048 x 2408 pixels, 11.3 x 11.3 mm, 5.5 x 5.5 µm pixel
WinCamD-LCM2	¾" CCD sensor for CW and pulsed, 1600 x 1200 pixels, 8.8 x 6.6 mm, 5.5 x 5.5 µm pixel
WinCamD-LCM1	½" CCD sensor for CW and pulsed, 1024 x 1024 pixels, 11.3 x 11.3 mm, 11.0 x 11.0 µm pixel
WinCamD-UCD12	½" CCD sensor for CW and pulsed, 1360 x 1024 pixels, 6.3 x 4.8 mm, 4.65 x 4.65 µm pixel
WinCamD-UCD23	¾" CCD sensor for CW and pulsed, 1360 x 1024 pixels, 8.8 x 6.6 mm, 6.45 x 6.45 µm pixel
WinCamD-UCD15	1/1.8" CCD sensor for CW and pulsed, 1600 x 1200 pixels, 7.1 x 5.4 mm, 4.4 x 4.4 µm pixel
BladeCam-HR	½" CMOS sensor for CW and high PRR, 1280 x 1024 pixels, 6.6 x 5.3 mm, 5.2 x 5.2 µm pixel <i>also available in WinCamD- WinCamD-UHR</i>
BladeCam-XHR	½" CMOS sensor for CW and high PRR, 2048 x 1536 pixels, 6.5 x 4.9 mm, 3.2 x 3.2 µm pixel <i>also available in WinCamD- WinCamD-XHR</i>
TaperCamD-UCD12	WinCamD-UCD12 with 14.4 x 10.8 mm 2.25:1 FO taper on the sensor
TaperCamD20-15-UCD23	WinCamD-UCD23 with 20 x 15 mm 2.27:1 FO taper on the sensor.
-1310	Adds 50 mm C-mount tube and long-pass filter for 1290 to 1350 nm work.
-UV	Camera with 3 mm UG11 filter instead of ND 4.0. Works at 260 through 380 nm.
-IR	On-chip IR to visible phosphor converter for 1480 to 1600 nm.
-FIR2-16	Complete IR camera for 2 to 16 µm

Extra cameras are available at a reduced cost and come with Cable, Mount and ND filter, but no Software or User Manual. Confirm with factory.

Add additional suffix **-X** to the system Part #. E.g.: **WinCamD-UHR** becomes **WinCamD-UHR-X**

Accessories

EAM-2	Variable Attenuator, 93 dB optical dynamic range. Max.: 1 W/cm ² ; 100 mJ/cm ² .
CUB & CUB-UV	Vis & UV Beam wedge splitters, 3% to 10% (polarization dependent) C-mount to camera.
ND0.5, ND1.0, ND2.0, ND3.0, ND4.0, ND5.0	Additional Neutral Density filters in ND 1 steps in stackable C-mount threaded holders. (ND4.0 filter comes as standard with the system.). See User Manual for curves. (Add L after ND for use with TaperCamD20-15, e.g. ND _L 3.0)

M-Squared Option for WinCamD – USB 2.0

M2DU-WC	WinCamD-Series USB 2.0 M ² Scan: 2.5 µm steps, 44 mm travel add lens below. (Order Lens assembly separately) UV, VIS, NIR, FIR Focal lengths from 50 – 1000 mm
---------	--

Other DataRay Profiling Instruments

BeamMap2	Real Time M-Squared Multi-plane profiler 0.1 µm resolution on CW lasers. Focus, Alignment, Divergence, M ² Visible and Telecom wavelengths, Dual Detector 190 nm to 2.4 µm.
Beam'R2	0.1 µm sampling on CW lasers, 0.5 µm to 4 mm beam dimensions, Dual Detector 190 nm to 2.4 µm.
BeamScope-P8	100 µm to 23 mm, M ² accessory option, ISO 11146 Standard Linear scanning slit, CW or Pulsed (PRR >5 kHz) lasers, up to 23 x 45 mm scanned area, 190 nm to 1.8 µm.

TaperCamD for Direct Imaging of Larger Beams

TaperCamD20-15-UCD23 series beam profiling cameras are unique to DataRay and offer a larger effective imager area. TaperCamD cameras offer direct imaging of the beam without any of the Gaussian beam near-field/far-field issues that arise with the use of beam expansion telescopes.

They are available in standard, -1310 and -NIR versions.

Fiber optic tapers are fused coherent fiber bundles, heated, drawn and polished to give an output end the size of the imager chip. The image is **de-magnified** ($M < 1$) from the faceplate input to the imager chip end. The taper ends are bonded to the surface of the imager chip using a proprietary DataRay process which eliminates both surface reflections and thermal cycling stress.

- The PMF (Pixel Multiply Factor) shown below and on the camera label is entered into the software in order to provide correct diameter readings.
- NA at the imager end is 1.0. NA at the input faceplate is a factor of M smaller (0.45) light at higher angles will be attenuated.
- The individual fibers at the input end are 6 μm pitch with a 50% core/cladding area ratio.
- Refractive index is 1.81, leading to a front surface reflectivity of 8.3%.
- Residual distortion is specified by the manufacturer at $\pm 3\%$ barrel/pin-cushion distortion. In our experience this distortion is concentrated towards the edges of the field.
- Residual non-uniformity in optical response is generally small and requires no correction, but the ability to do so is available in the software.
- Empty filter holders are available for both TaperCamD sizes.
- A 0.25" deep extension ring is available with male and female 1.30"-20 tpi threads.

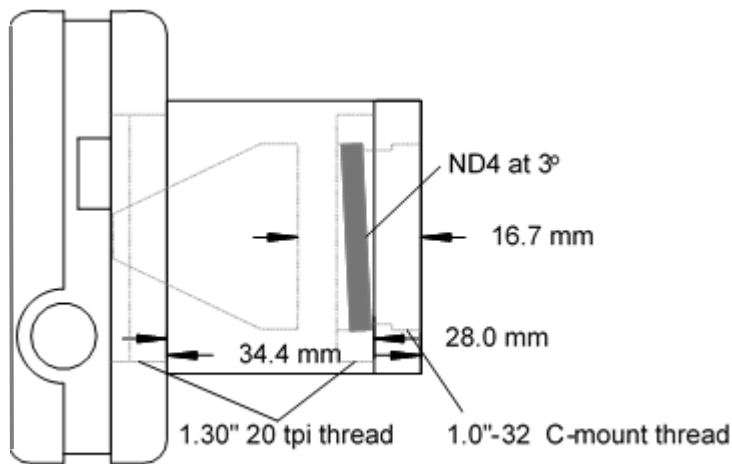

Imager area is shown
actual size in mm for:

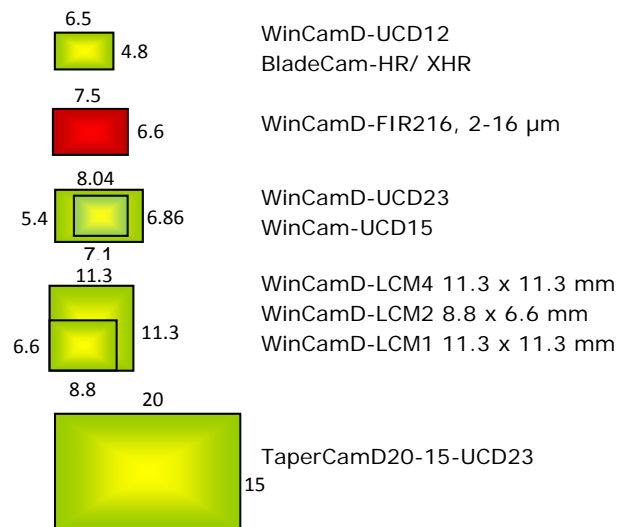

TaperCamD20-15-UCD23, **PMF = 2.27**

WinCamD-XXXX-1310: High Resolution beam profiling to 1350 nm.

Image of a 1310 nm beam, 100 μm diameter, 1.5 mW. [43 ms Shutter, no ND filter]

The high resolution advantage of 4.65 μm square pixels is clearly seen. (WinCamD-UCD12)

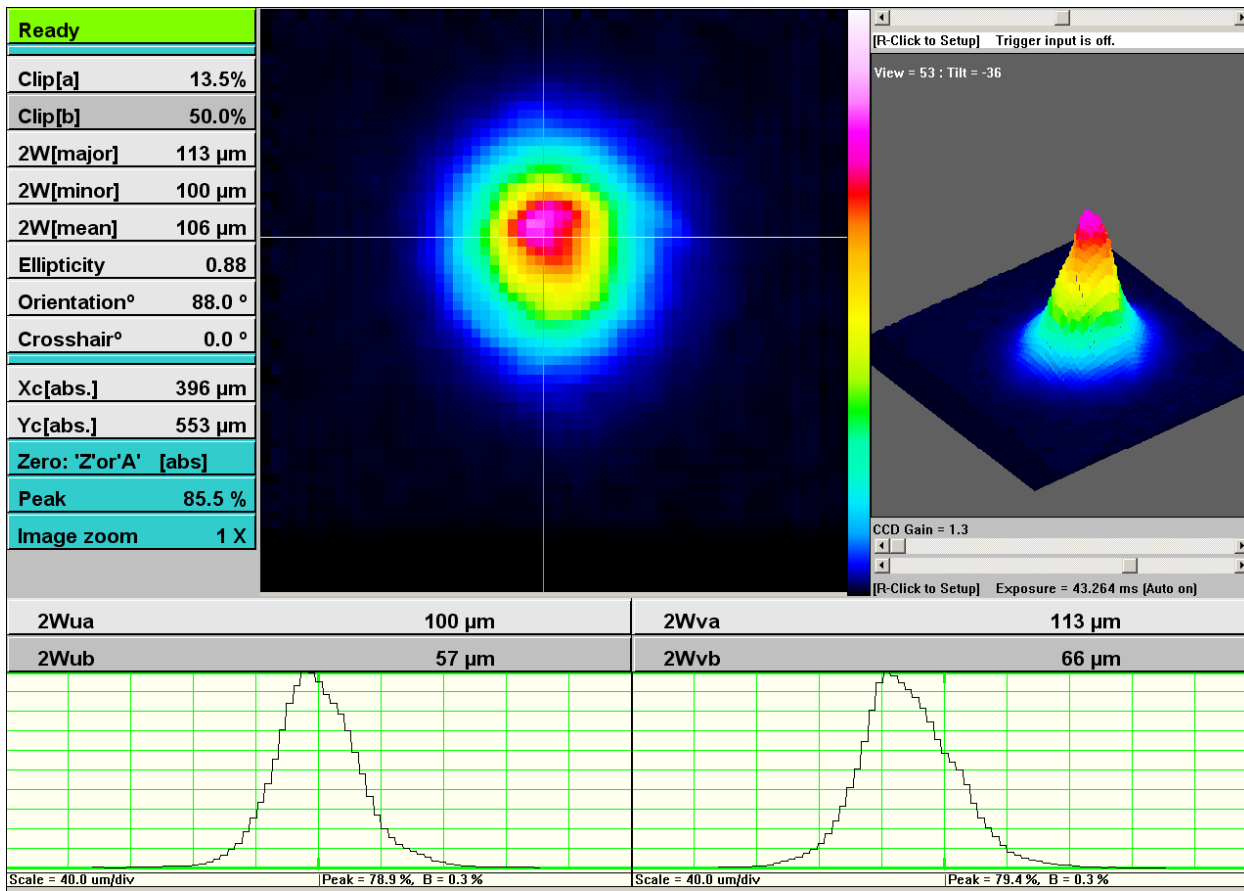

Summary:

- Technology.** WinCamD-XXXX-1310 uses proprietary software and electronics in conjunction with sensors that exhibit residual sensitivity at 1310 nm. This is a tailing silicon response, and has been observed out to at least 1340 nm. The effective Quantum Efficiency (QE) in this tailing response is around 0.01%, i.e. a factor of around $\sim 10^4$ down on the visible response.
- Features.** Despite the low QE, WinCamD-XXXX-1310 cameras can be very attractive for 1310 nm region use if the source irradiance is adequate (see later). The small 5.5/4.65 micron square pixels give much higher resolution than standard NIR cameras. The WinCamD shutter exposure of up to 1047 ms is 25 to 30 times greater than that of standard cameras, partially compensating the low 1310 nm sensitivity.
- Operational Issues.** ND filters are not normally used with WinCamD-XXXX-1310, unless the beam power is very high, meaning that normal laboratory background can dominate the 1310 nm signal. Options are:

- Use no filter and work in a darkened room, or with black screening
- Use a long pass filter which blocks radiation below the wavelength(s) of interest.

DataRay supports both options.

- ◇ **No Filter Operation.** With no shading or filtering, a typical room background level is equivalent to an exposure time of ~ 3 ms. i.e. the background is $\sim 10\%$ of the signal when the exposure time with signal is ~ 0.3 ms. This emphasizes the need to suppress the ambient light as far as is possible. Working in a darkened lab is the best solution.
- ◇ The provided 50 mm long, 30 mm OD, black-anodized C-mount tube, reduces ambient lab background by a factor of around 4.
- ◇ A 100 mm long tube will reduce the ambient lab background by a factor of around 8.
- ◇ With thin black card and tape, you can mount your own custom tube off the provided 50 mm C-mount extension, and customize the ambient suppression shading to your application.

- ◇ **Long-Pass Filter Option.** DataRay provides the WinCamD-XXXX-1310 camera with an angled, C-mount WCD-LPF1290 custom long pass filter, with $\geq 80\%$ transmission above 1295 nm, 50% transmission at 1290 nm, 1% transmission at 1285 nm, fully blocked below 1250 nm.
- ◇ This filter provides very effective blocking of visible light, e.g. ambient light or laser pump signal. It has a custom construction to minimize fringing effects, but can still lead to some fringing due to internal reflections in the filter sandwich and between the filter rear surface and the CCD. Filters with lower cut-on wavelengths can be obtained to special order.
- ◇ **Exposure Time.** Use the graph below to estimate the required exposure time for your beam.
- ◇ **Maximum Beam Power.** Note the red line indicating to the maximum power of 100 mW allowed on the CCD. Above this level, you must use sampling or attenuation to reduce the beam power.

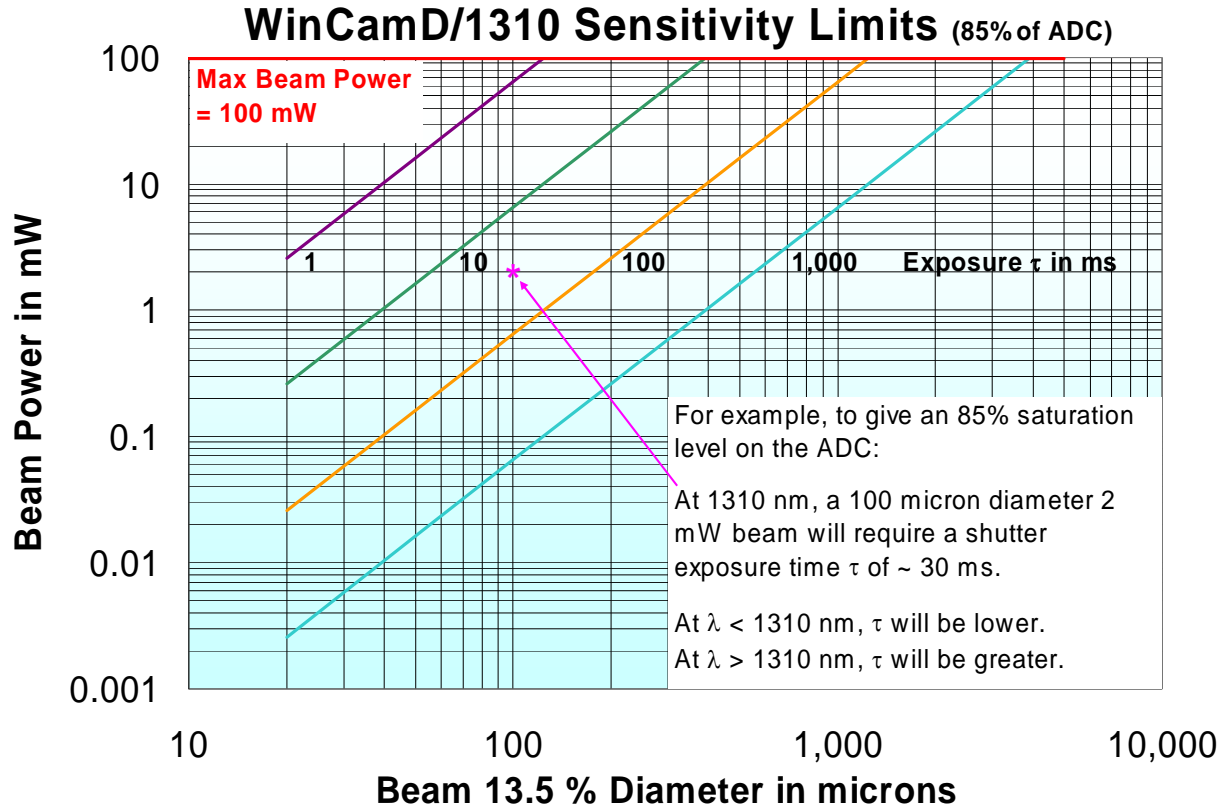

WinCamD, WCD-LPF1290 long pass filter, CM-50 50 mm tube,

3 m cable, Software CD, User manual.

WinCamD-NIR: Economical Telecom beam profiling, 1475 to 1600 nm

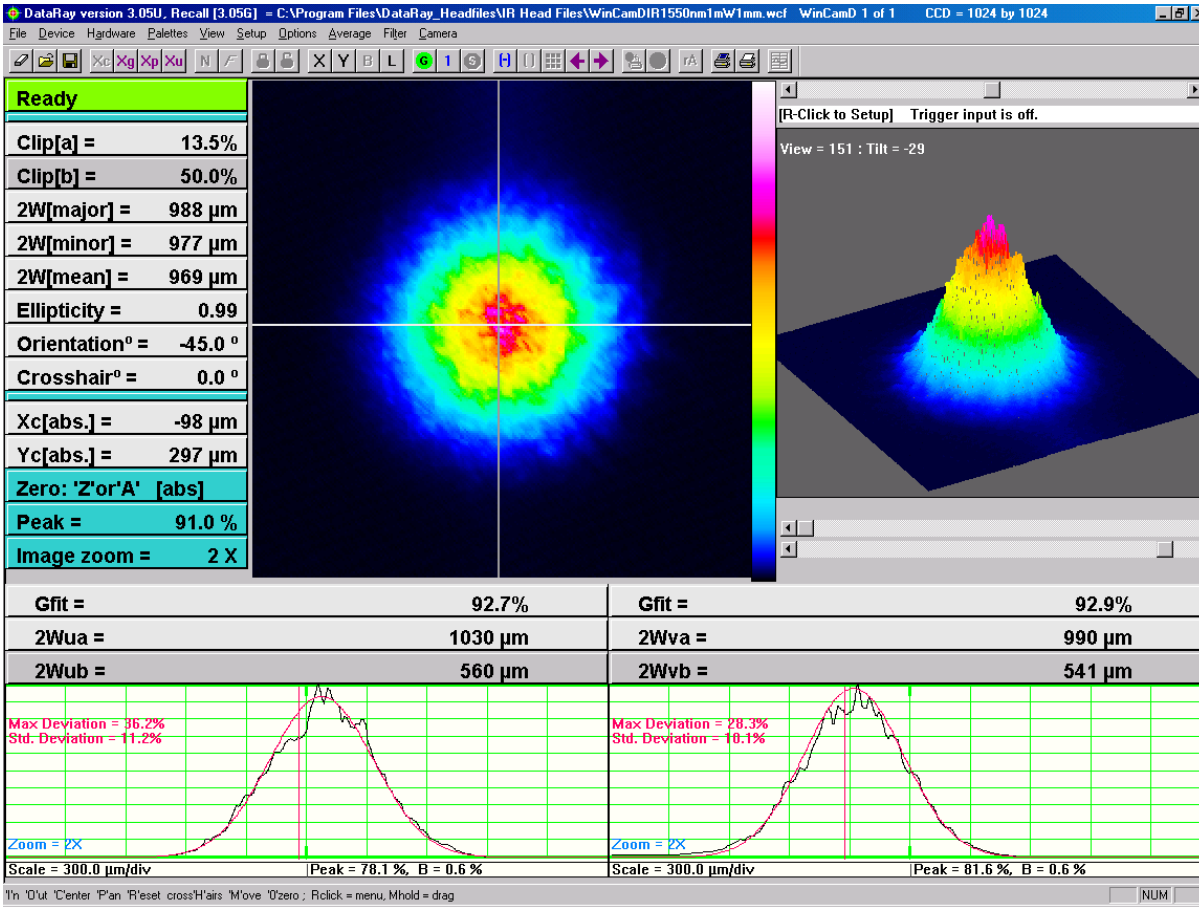

WinCamD-Series-NIR & TaperCamD-NIR for Telecom C & L bands

- ◇ 1475 to 1600 nm, IR to visible conversion phosphor on Silicon CCD
- ◇ $\approx 25 \mu\text{m}$ FWHM point spread function due to phosphor ($\approx 70 \mu\text{m}$ for **CamIR Adapter**)
- ◇ $\pm 10\%$ spatial response non-uniformity due to phosphor
- ◇ $\sim 20 \mu\text{W}$ to 100 mW, for 1 mm diam. @1550 nm. (With 0.02% transmission (1550 nm) ND filter)
 - e.g. 10 ms exposure on 1 mW, 1 mm diameter beam at 1550 nm.
- ◇ **Gamma:** Signal = (Incident Irradiance) ^{γ} where $\gamma = 1.414$.

Gamma (γ) correction is included in the software.



CamIR Adapter with C-mount

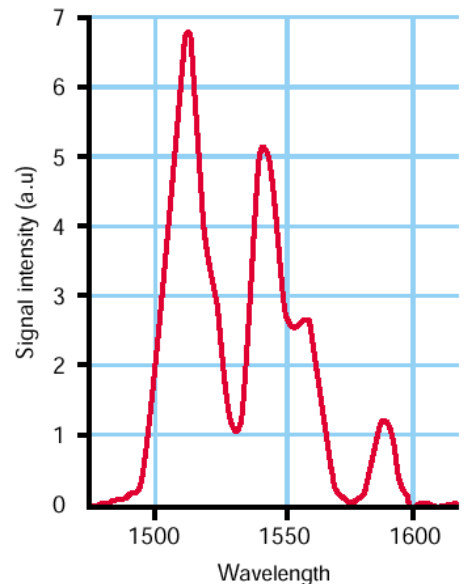

3.5:1 faceplate to sensor image reduction

46 mm diam. x 97 mm long

NEW WinCamD-FIR2-16-HR

Compact, Portable, Port-Powered, USB 2.0 **10.6 μm** Beam Profiling for Windows 8, 7, XP & Vista, 32 or 64 bit operating systems

Features

- ◇ **17 μm pixel pitch, 640 x 480 pixels, 10.9 mm x 8.2 mm**
- ◇ **2 to 16 μm wavelength range microbolometer**
- ◇ **Port Powered USB 2.0;** flexible 3 m cable, *no power brick*
- ◇ **12-bit ADC,** 4 MB image buffer & on-board microprocessor
- ◇ **16 ms time constant**
- ◇ **No Chopper** Measure Pulsed or CW Beams
- ◇ **Room Temperature** - no cooling required

Applications

- ◇ CO₂/FIR laser profiling
- ◇ Field servicing of CO₂ lasers and laser-based systems
- ◇ Optical assembly & instrument alignment
- ◇ Beam wander & logging



2.40 x 2.65 x 2.05" (1.86" without filter)
[61 x 67 x 52.15 mm]

Compact, Room Temperature, Port Powered WinCamD-FIR cameras.

Features:

- ◇ Digital serial link for EMI immunity
- ◇ XY profiles and centroids
- ◇ Linear and logarithmic displays
- ◇ Gaussian and Top Hat least squares fits
- ◇ Ellipse Angle, Major, Minor, Mean Diameters
- ◇ Background capture and subtraction
- ◇ Image & Intensity Zoom
- ◇ Linear and area filters
- ◇ Image Averaging, 1 to continuous
- ◇ PC Or Mac-Intel Operation

WinCamD-FIR Specifications

Wavelength Ranges	~2 to 16 μm
Pulsed lasers	pulse rep rates should be greater than 100 kHz
Compact	2.40" x 2.65" x 2.05" [61 x 67 x 52.15 mm]
Interface	USB 2.0 for laptops & desktops, 3 m standard thin cable, 5 m option USB 3.0 compatible.
ISO 11146	Beam profile Second moment processing
Certification	RoHS, WEEE, CE
Measurable Sources	CW beams, Pulsed sources: <i>free-running, not triggerable</i> ; average pulses over the ≈ 20 ms exposure period or with frame averaging. Mean irradiance limits still apply.
Measured Beam Powers	Contact Application Engineer for options
Manual Beam Attenuation:	Contact Application Engineer for options
Measurement Accuracy	5 μm processing resolution for interpolated diameters. Absolute accuracy is beam profile dependent – ~ 35 μm accuracy is frequently achievable. Centroid accuracy is also beam dependent. It can be as good as ± 20 μm since it is arithmetically derived from all pixels above the centroid clip level.