



OPTOGAMA

电话: 0755-84870203

邮箱: sales@highlightoptics.com



海纳光学

MANUAL v2.2

KEY for DISCOVERIES

NEW COMPACT MOTORISED BEAM EXPANDERS V2

1x - 3x | 1x - 8x

MEX13-v2

MEX18-v2

MEX18-ACH-v2



Table of contents

Table of contents	2
1. Safety requirements	4
2. Operation principle.....	5
3. Features and advantages.....	5
4. Optical design	5
5. Product description.....	6
5.1.Optical specifications.....	6
5.2.Mechanical specifications.....	6
5.3.Electronic specifications	6
5.4.Conditions.....	6
5.5.Interfaces	6
5.6.Wiring, Pinouts.....	7
5.7.Voltage levels (RS-232).....	7
5.8.What's in the box?.....	7
6. Software	8
6.1.Hardware requirements (recommended).....	8
6.2.System requirements.....	8
6.3.Supported client operating systems	8
6.4.Installing the software.....	8
6.5.Using the software	9
6.6.Main window.....	10
6.7.Magnification calibration. MOF coefficient.....	11
6.8.Divergence adjustment. DOF coefficient.....	11
6.9.Divergence adjustment range. DOFR values.....	11
6.10.Magnification offset range. MOFR values.....	11
6.11.Current MOF and DOF values.....	11
6.12.Updating the firmware	12
7. Commands.....	14
7.1.Interface.....	14
7.2.Description.....	14
7.3.Serial communication example in Python.....	18
9. Technical drawings.....	19

MEX-v2

NEW Motorised beam expander

Congratulations on your purchase of the motorised beam expander from Optogama, UAB.

March 2023

Copyright UAB Optogama. All rights reserved.

No part of this manual may be reproduced or transmitted in any form without the permission of Optogama.

Claims will not be accepted, and warranty repair will not be carried out in case of improper use, incorrect service, and maintenance not according to product instructions. Warranty claim shall not be accepted if there are any signs of:

- Non-authorized alteration
- Disassembling of the device
- Mechanical or any external damage
- If warranty term has expired
- Serial number of the product is missing

Symbols

CAUTION!

Sections marked with this symbol indicate dangerous situations that can result in damage to the device, components connected to it or operator.

NOTE:

Sections marked with this symbol indicate important information on beam expander or about this manual.

Due to constant development of our products, we reserve the right to make changes on the production line without further notice. Up-to-date information is available at our website www.optogama.com. If there are any further questions, please contact us.

Optogama is not liable for damage or injury resulting directly or indirectly from use of this product for anything other than its intended purpose.

The motorised beam expander is intended for industrial and scientific use only. If there are any other electrical devices connected to or used in conjunction with the beam expander, all legal regulations and technical standards that are applied to those devices must be observed as well.

For any technical assistance and consultation please contact your local dealer or directly sales@optogama.com.

1. Safety requirements

- All safety instructions must be followed.
- This manual should be read carefully before first intended use.
- All rules and regulations concerning safe operation of lasers must be known and applied while installing and operating motorised beam expander.
- Even with safety glasses avoid eye contact with direct or scattered laser light while assembling, installing, and operating the device.
- The device should never be exposed to dirt, dust or moisture.
- Before any operation make sure the device is installed correctly and well adjusted.
- Protective measures should be considered if necessary.
- Electrical safety requirements must be complied with while operating this device.

CAUTION! High laser output power may damage or destroy optical elements.

CAUTION! Make sure laser beam is not converging after passing through the beam expander - it may damage other optical elements along the optical axis.

CAUTION! Device is meant to be used with collimated beam. Users take full responsibility when using the expander with highly converging beam.

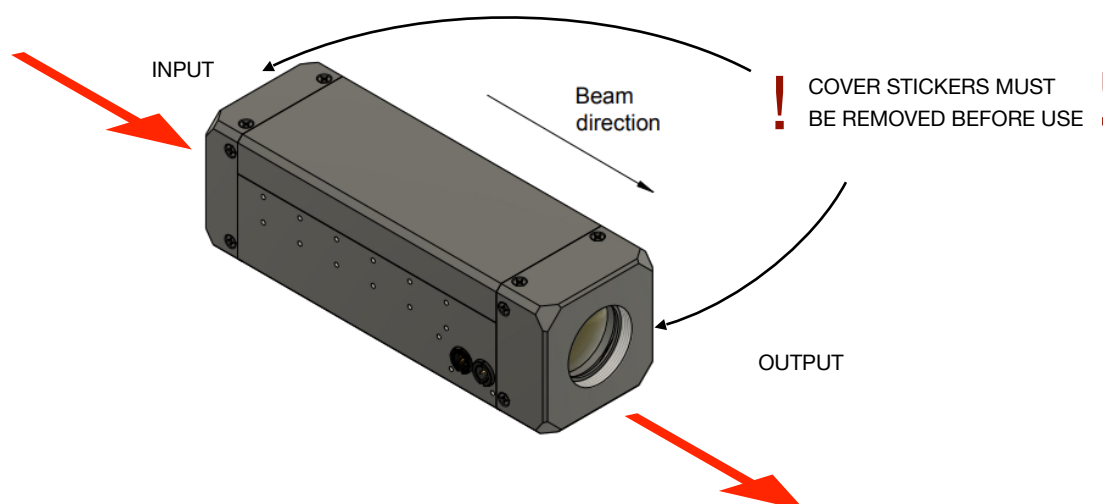

2. Operation principle

MEX13(18) series motorised beam expanders consist of two motorised adjustable lenses. Expansion adjustment is achieved by changing the position of the second lens which is followed continuously by the first one. While changing the magnification level this technology prevents the system from focusing laser beam and damaging optical elements that are situated along the optical axis.

NOTE: No homing required.

CAUTION! Before increasing laser power make sure laser beam is not converging after passing through the beam expander. It may damage optical elements situated along the optical axis.

NOTE: Required laser beam divergence is achieved by adjusting divergence value (**DOF** coefficient) in the software (or terminal).

3. Features and advantages

- Absolute encoders
- All in one design - integrated controller
- Highest beam pointing stability (< 0.1 mrad on request)
- Fused silica optical elements
- No homing required
- Diffraction limited performance for all magnifications
- Two lenses simultaneous SMART movement
- Optimized for 24/7 usage

4. Optical design

To achieve best performance and highest pointing stability during operation (<0.3 mrad, <0.1 mrad for PS model) MEX optical design is based on sliding-lenses closed loop design. Neither of the lenses are rotating while changing both zoom and divergence levels.

Optical design of MEX13 and MEX18 series (see Fig 1. below):

Converging > Diverging > Converging

NOTE: Continuous change of expansion and divergence.

NOTE: No ghost reflections.

NOTE: Diffraction limited optical design.

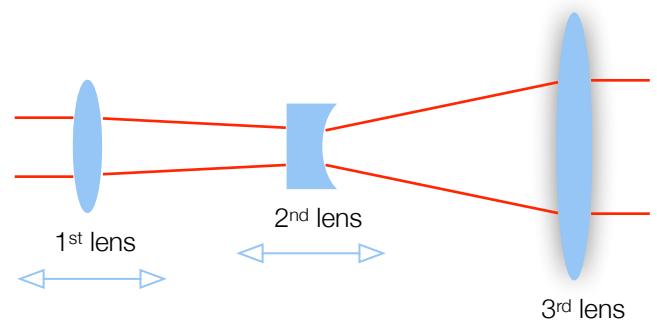

Fig 1. Schematic explanation of optical design for MEX13 and MEX18 series motorised beam expander.

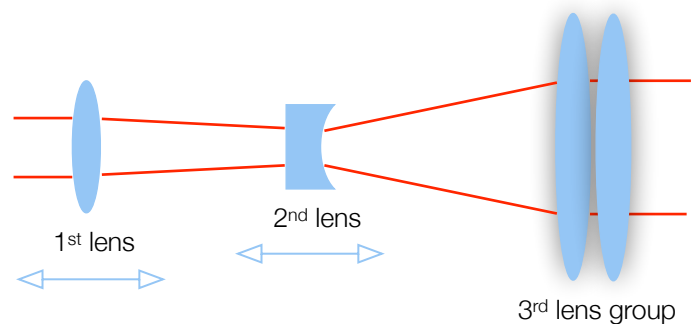

Fig 2. Schematic explanation of optical design for MEX18-ACH series motorised beam expander.

5. Product description

MEX series motorised laser beam expanders are used to increase or decrease laser beam diameter and adjust its divergence.

Standard or custom-made beam expanders and reducers have a unique closed loop sliding-lens design, ensuring highest pointing stability and minimal dimensions.

5.1. Optical specifications

Magnification ranges	MEX13 - 1.0x - 3.0x MEX18 - 1.0x - 8.0x		
Clear input aperture	11 mm		
Clear output aperture	MEX13 - 23 mm MEX18 - 38 mm MEX18-ACH - 23 mm		
Optical elements	3 4 (MEX18-ACH)		
LIDT coating	10 [J/cm ²] (10 ns @ 1064 nm)		
Pointing stability during lens movement	<0.5 mrad (<0.2 mrad for PS version)		
Adjustment time	MIN to MAX <1 sec		
Available coatings			
A. Standard wavelengths, nm			
	1 st harm	2 nd harm	3 rd harm
	1064	532	355
	1020 - 1040	510 - 520	343
	760-840	390 - 410	-
B. Dual wavelengths, nm			
	1064 + 532	1030 + 515	800 + 400
C. Custom wavelengths			
	Custom coating available		

5.2. Mechanical specifications

MEX13 MEX18 MEX18-ACH

Lenght	140 mm	237 mm	226 mm
Width	45 mm	45 mm	45 mm
Height	45 mm	45 mm	45 mm

5.3. Electronic specifications

Interface options:

Terminal	Using commands described in p. 8 "Commands"
Software	Using BDS software
Input voltage	12 V
Recommended current	2 A
Standby current	100 mA
Transmission speed	RS-232 up to 921,600 bits/s standard 115,200 bits/s full speed USB 2.0

5.4. Conditions

Operating temperature	10 °C to 40 °C
Storage temperature	-15 °C to 50 °C

5.5. Interfaces

There are two type of connections available:

1. USB 2.0 and power plug for 12 V.
2. RS-232 and power plug for 12 V.

5.6. Wiring, Pinouts

Connectors and plugs (contacts):

Type	Contact	Connector
Communication (same for USB and RS-232)	Binder 09-9789-00-05	Binder (modified) 09 9790-71-05
Power supply	Binder 09-9747-00-03	Binder (modified) 09-9748-71-03

Pinouts:

Power supply	Communication	
	RS232	USB
DC 12 V		
1. GND	1. RS232 RX	1. -
2. GND	2. -	2. USB D-
3. +12 V DC	3. GND	3. GND
	4. RS232 TX	4. -
	5.-	5. USB D+

NOTE: RS-232 cable has standard DB9 female connector at one end:

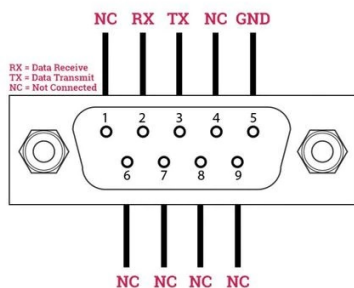

Fig 4. DB9 female connector pinout

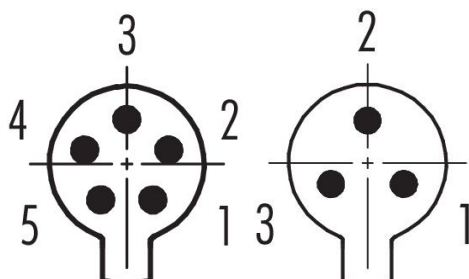

Fig 5. MEX connectors

5.7. Voltage levels (RS-232)

The RS-232 standard defines the voltage levels that correspond to logical one and logical zero levels for the data transmission and the control signal lines. Valid signals are either in the range of +3 to +15 volts or the range -3 to -15 volts with respect to the "Common Ground" (GND) pin; consequently, the range between -3 to +3 volts is not a valid RS-232 level. For data transmission lines (TxD, RxD), logic one is defined as a negative voltage, the signal condition is called "mark". Logic zero is positive and the signal condition is termed "space".

MEX operates on signal levels of ± 3.3 V and can accept signal levels of up to ± 15 V. Because the voltage levels are higher than logic levels typically used by integrated circuits, special intervening driver circuits are required to translate logic levels. These also protect the device's internal circuitry from short circuits or transients that may appear on the RS-232 interface and provide sufficient current to comply with the slew rate requirements for data transmission.

5.8. What's in the box?

Standard version includes:

1. Motorised beam expander
2. Software
3. Power supply DC 12V (GST60A12-P1J with modified snap in 09-9748-71-03 connector)
4. USB-A or RS-232 (D-Sub 9) cable with modified snap in 09 9790-71-05 connector

NOTE: Other accessories must be purchased separately

6. Software

6.1. Hardware requirements (recommended)

Processor	1 Ghz
RAM	512 Mb
Disk space	
32-bit	4,5 Gb
64-bit	4,5 Gb

6.2. System requirements

To install application, you must have administrator rights on your computer.

To run BDS application Microsoft .NET 4.5.2 Framework or later must be installed. Installer detects Microsoft .NET Framework and installs it if required. Administrator privileges are required for installation. Contact your network administrator if you do not have administrator rights on the computer.

6.3. Supported client operating systems

- Windows 7 SP1 and later versions
- Windows Server 2008 SP2/R2
- Windows Server 2012 (.NET included with OS)

6.4. Installing the software

5. Check and download the latest BDS software from our website (www.optogama.com) or contact us directly at sales@optogama.com.
6. Run the downloaded software installation file. Installation window will appear, click “Next” to continue:

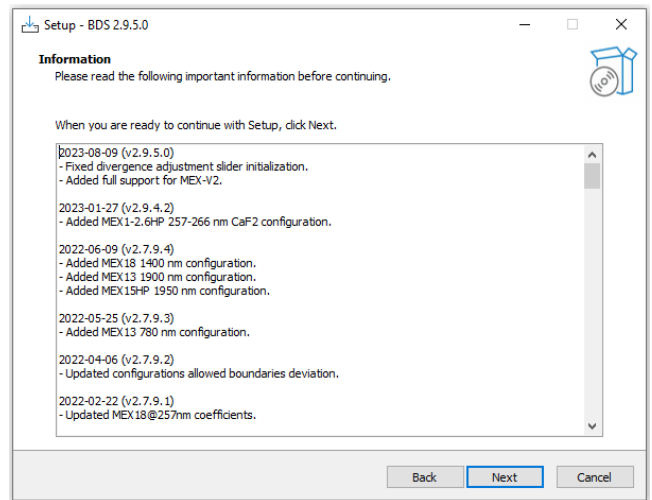

7. Select “Create a desktop shortcut” if it is necessary and click “Next”:

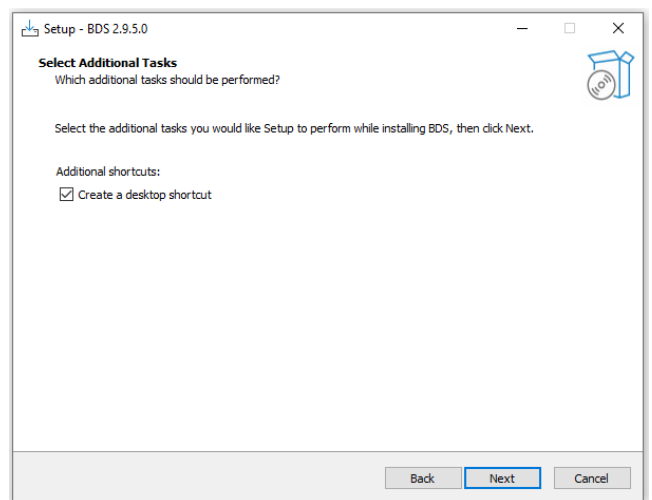

8. Review setup information and proceed with the installation. To continue click “Install”:

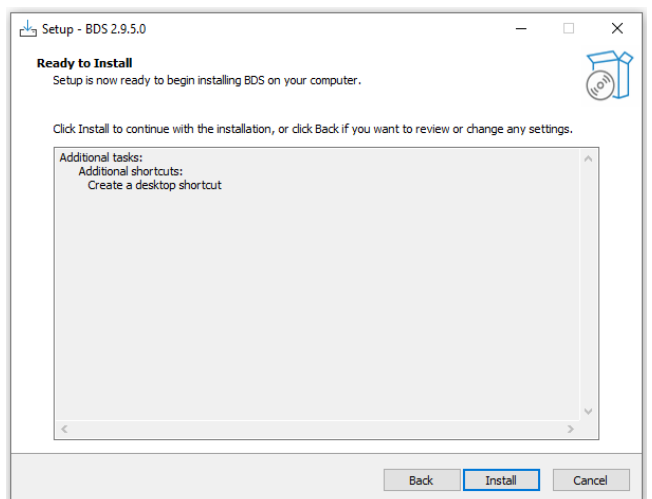

9. Setup will finish the installation:

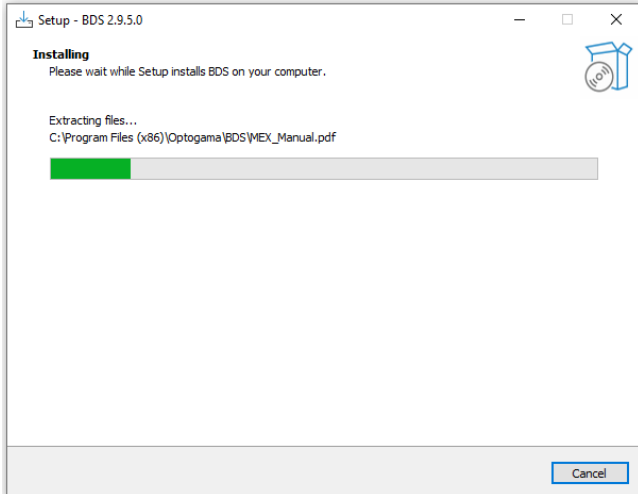

10. Press "Finish" to end the installation:

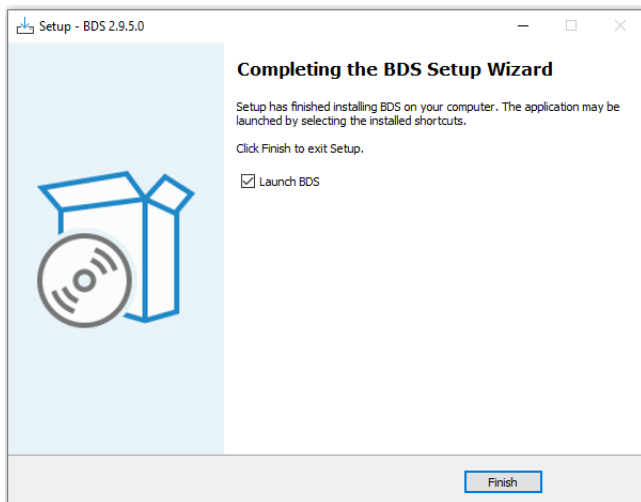

11. Connect the device and the PC via USB or RS232 cable.

NOTE: Lenses may move themselves when power is plugged in.

12. Plug in MEX power supply and AC adaptor to wall outlet.

13. The device will be detected and configured.

14. The device installation is complete.

6.5. Using the software

CAUTION! Do not switch the laser ON if the device is not adjusted properly, it may damage or destroy optical elements.

Launch BDS program using BDS icon on the desktop.



15. Device selector window will appear. Select COM port (to which the beam expander is connected) from the drop-down menu. Press "**Connect**" to connect the device or "**Rescan**" if your device is not visible. Select "**Filter**" when device is connected via USB cable. All other COM ports will be hidden except our device.

NOTE: When connecting via RS232 cable "Filter" must be deselected, otherwise device will not be visible.

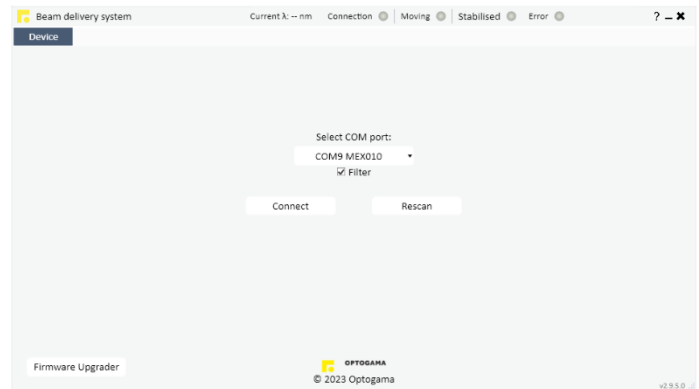

16. Once you are connected to your device you will be greeted by main program window for motorised beam expander. Window is the same for all devices but only specific options for control will be available. (Detailed explanation in p. 11 "Main window (expander mode) / (full beam control mode)").

17. Select "Settings" in a sliding menu located on the left. Settings menu will appear. Select laser **wavelength** from drop down menu, then press "Set".

18. Change Magnification offset to calibrate magnification values (**MOF**)

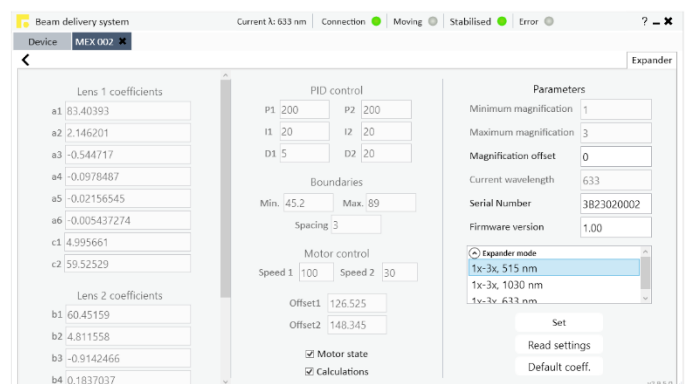

6.6. Main window

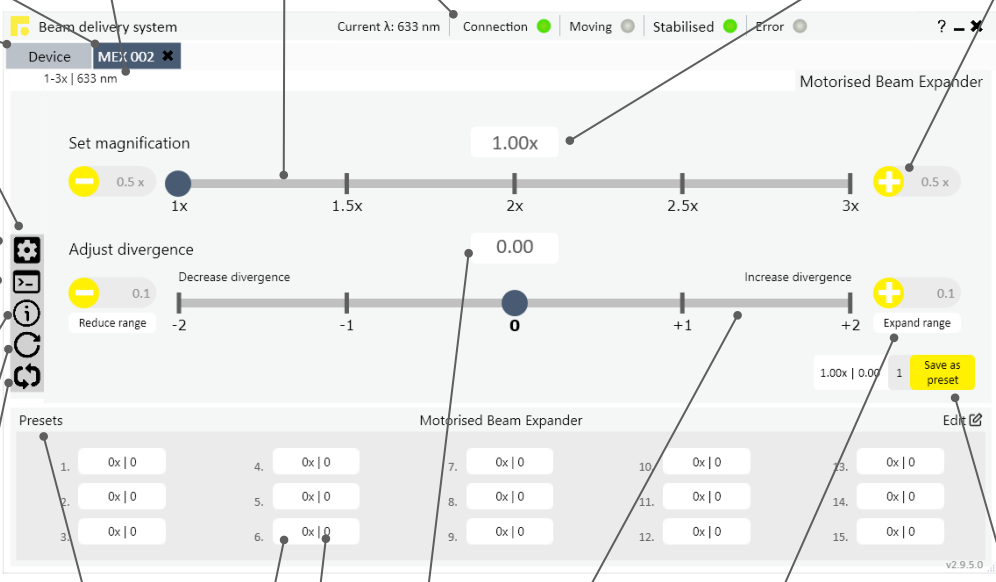

Connected device tab
Indicates available expansion range and selected wavelength

Device selector tab
Device: MEX 002
1-3x | 633 nm

Sliding Menu
Drag cursor to expand menu

Settings
Select this icon to open settings window in which laser parameters and Beam control mode could be changed

Command line
Select this icon to open command terminal window

Status flags
Select this icon to open menu where device status flags can be monitored. Flags are recorded until "Reset" button pressed.

Reconnect
Select this icon to reconnect the device if it is being disconnected

Demo mode
Select this icon to start demo mode which automatically changes magnification level by 0,5x step

Connection
Green - device is connected
Red - device is disconnected

Moving
Green - lenses are in motion

Stabilised
Green - lenses are stabilised

Error
Red - Indicates position error, click on it to reset.

Magnification Slider
Move the slider to change into required magnification level

Magnification value
Enter required magnification value. Press "Enter".

Buttons for incremental change
Click yellow button for incremental change. Double-click on the number to change the increment size.

Set magnification
1.00x

Adjust divergence
0.00

Reduce range
0.1

Increase divergence
0.1

Expand range
1

Save as preset

Presets
Motorised Beam Expander

1.	0x 0	4.	0x 0	7.	0x 0	10.	0x 0	13.	0x 0
2.	0x 0	5.	0x 0	8.	0x 0	11.	0x 0	14.	0x 0
3.	0x 0	6.	0x 0	9.	0x 0	12.	0x 0	15.	0x 0

Preset buttons
Click "Edit icon" to add preset required magnification and divergence offset values for a quick change

Magnification value (MAG)

Divergence offset (DOF)

Divergence offset value (DOF)
Enter required divergence offset value. Press "Enter".

Divergence Slider
Move the slider to change divergence value

Expand divergence offset range
Double-click "Less" and "More" to decrease or increase divergence offset range.

Save as preset
Save current magnification and divergence values as preset button in required slot.
Mag | Div - current values

6.7. Magnification calibration. MOF coefficient

Command is used to adjust all magnification values:

- input **>0** (positive values) to increase Magnification offset
For. Ex. *MEX>MOF!_+0.7*
- input **<0** (negative values) to decrease Magnification offset
For. Ex. *MEX>MOF!_-0.6*
- to reset Magnification offset input 0.
For. Ex. *MEX>MOF!_0*

NOTE: MOF coefficient will be applied for all magnification values.

For. Ex. 1X magnification value (MAG_1) is chosen, but according to your laser beam parameters 1.09X actual magnification value is reached, so to calibrate magnification to required value *MEX>MOF_-0.4* or other negative value could be sent while observing the output.

6.8. Divergence adjustment. DOF coefficient

Once you have right magnification value you can adjust beam divergence. To do that, you have to change DOF coefficient (Divergence offset) with *MEX>DOF!_value* command:

- input **>0** to increase beam divergence (positive values)
For. Ex. *MEX>DOF!_+0.7*
- input **<0** to decrease beam divergence (negative values)
For. Ex. *MEX>DOF!_-0.6*
- to reset Divergence offset input 0.
For. Ex. *MEX>DOF!_0*

NOTE: DOF coefficient will be applied for all magnification values. If different Divergence offset must be set it has to be adjusted each time.

For. Ex. You can observe that laser beam beam is diverging too much and it must be collimated. To do that *MEX>DOF_-0.5* or other negative value must be sent while observing the output.

6.9. Divergence adjustment range. DOFR values

The reachable minimum and maximum DOF value depends on magnification, MOF coefficient, and mechanical boundaries. Allowed range can be checked for each magnification by sending DOFR command.

For. Ex. *MEX>DOFR? → MEX>DOFR_4.832_-3.587*

4.832 is maximum DOF value

-3.587 is minimum DOF value.

6.10. Magnification offset range. MOFR values

Magnification offset also depends on magnification, DOF coefficients, and mechanical boundaries. Allowed MOF range can be checked for each magnification by sending MOFR command.

For. Ex. *MEX>MOFR? → MEX>MOFR_8.855_-3.587*

8.855 is maximum MOF value

-3.587 is minimum MOF value.

NOTE: It is recommended to firstly adjust MOF value keeping DOF=0.

6.11. Current MOF and DOF values.

Since DOF and MOF are applied for all magnifications at some value they may exceed reachable DOF or MOF range (DOFR and MOFR). In this case DOF and MOF are set to maximum or minimum possible value and status flag is set that DOF or MOF exceeds allowed range.

For. Ex. *MEX>DOF? → MEX>DOF_3.5*

MEX>DOFR? → MEX>DOFR_2.951_-6.857

MEX>DOFC? → MEX>DOFC_2.951

Also, DOF boundary violation bit is set for status.

6.12.Updating the firmware

If your device firmware version doesn't match to software's firmware version while first time connecting to device via BDS software, you'll be asked to update your device. If an update request pops-up, but you want to keep current firmware and use BDS software, it can be ignored. It is recommended to keep the software and firmware up to date.

To update your device or rewrite device firmware - **USB cable or RS232 cable** must be used.

1. Click button "**Firmware Upgrader**" in the main tab of BDS software:

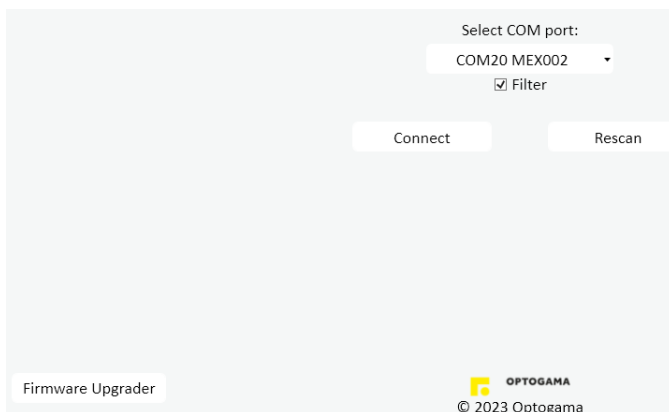

2. In the opened window **select COM port** and press "**Update**" button. You will be asked if you really want to update device:

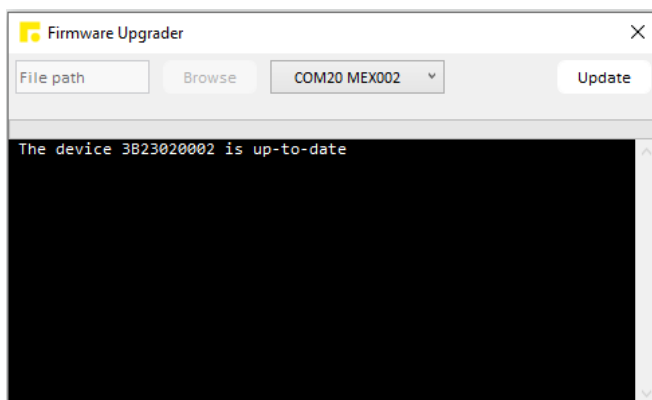

3. After a warning device **motors will be shut down** and update will start:

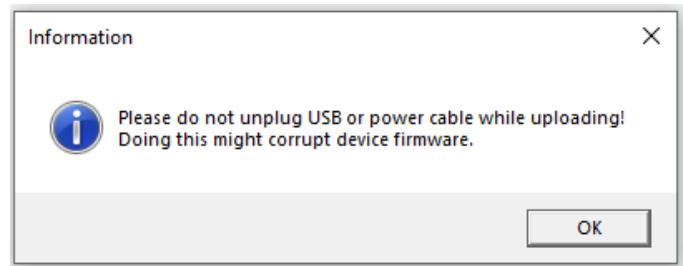

4. During update, if device is not corrupted, there'll be created a backup of settings stored in your device.

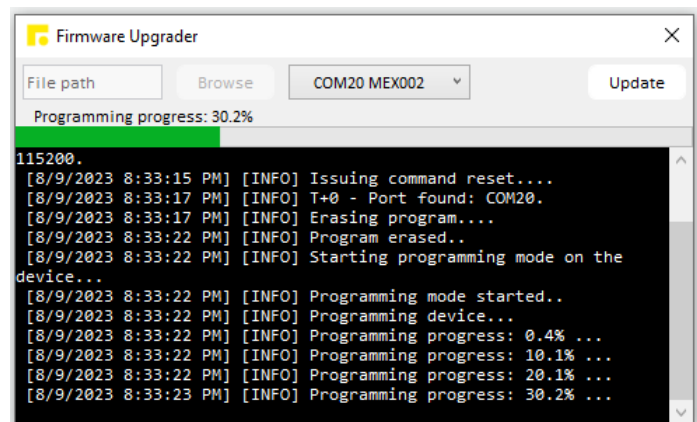

5. Update should be done in about a minute. If everything went successfully message box like this should pop-up:

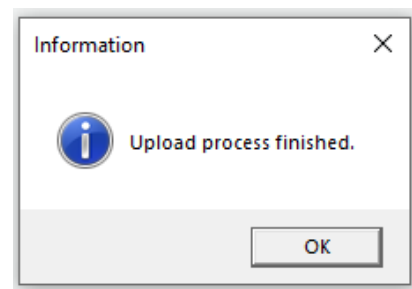

NOTE: After the update process is finished **motors and calculations must be turned on manually** in settings window.

6. You may get a warning sign saying that you must set default coefficients in case after update device settings memory addresses have changed or some settings are corrupt:

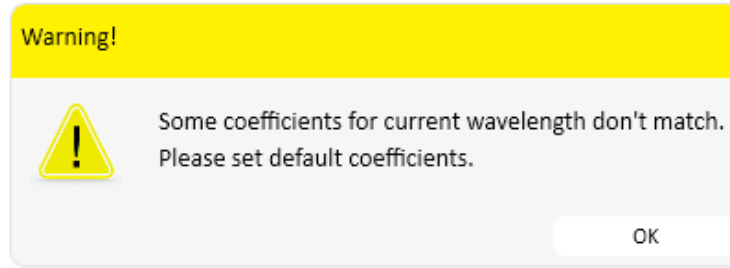

7. In order to rewrite default coefficients go to **Settings** -> **choose wavelength** -> Press "**Set**" -> Press "**Default coeff.**"

NOTE: To rewrite coefficients for all wavelengths you must repeat this action for all available wavelengths.

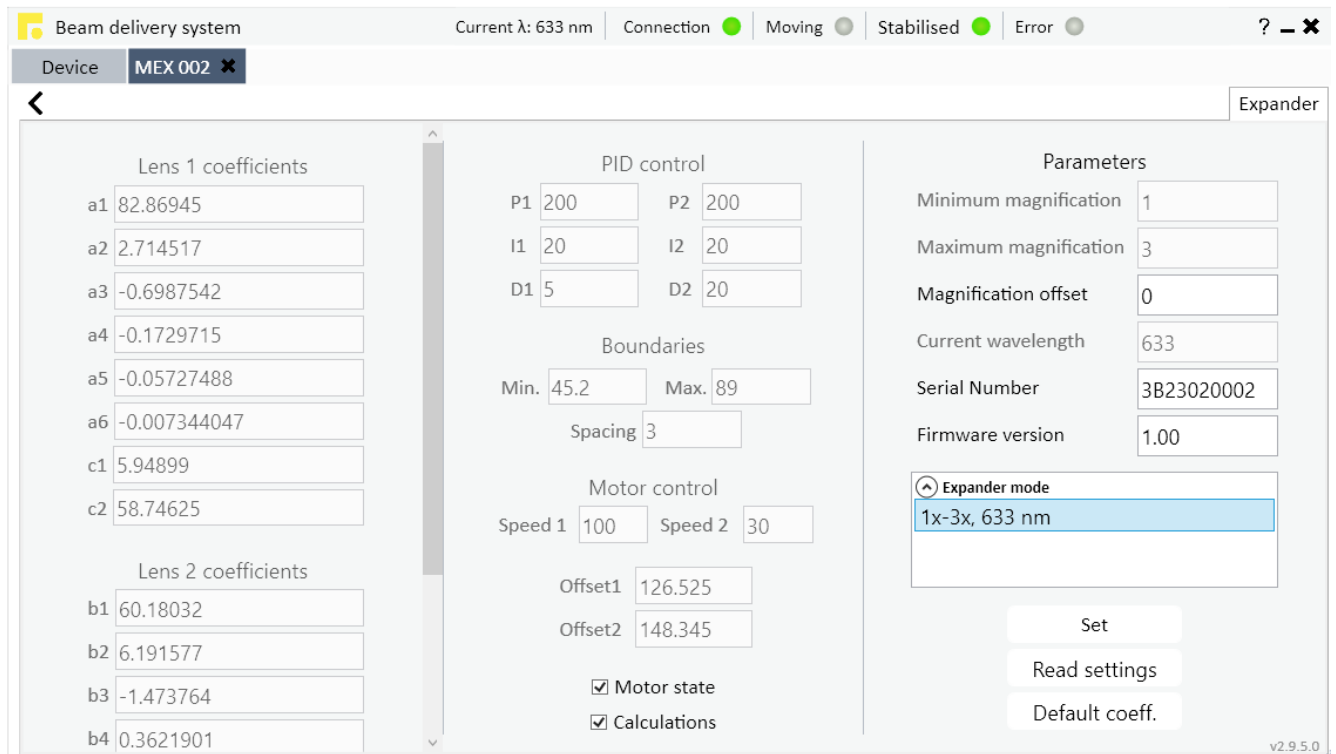

8. Finally, choose desired wavelength, check if "**Motor state**" and "**Calculations**" are marked then press "**Set**". Coefficients for the wavelength will be automatically changed by device. Now you're ready to go.

7. Commands

7.1. Interface

The MEX can be controlled using either **USB 2.0** or **RS-232** interface. The device will switch to the required interface upon connection of the appropriate cable.

When using the RS-232 interface, MEX communicates on the **configured Baud rate (by default 115200)** (see Command descriptions), using **8 data bits, no parity and 1 stop bit**.

When the device is connected to the PC through the USB interface, it will appear as a **Virtual Serial COM port**, so

all PC side communications are interchangeable between the two interfaces.

All communications with MEX are conducted by sending **literal ASCII string commands terminated with the newline character \n or carriage return \r**. For example, the beam expansion coefficient can be set to 2.5 by issuing a **"MEX>MAG!_2.5\n"** command to which the device will respond with **"MEX>MAG_2.5\n"**.

7.2. Description

Command	Response	Comments	Example usage	
			User command	Device response
Motion Magnification - MAG, Magnification offset - MOF, Divergence offset - DOF				
MEX>MAG?	MEX>MAG_X.XXX	Command used to get the current magnification value from the device.	MEX>MAG?	MEX>MAG_1.250
MEX>MAG!_X.XXX	MEX>MAG_X.XXX	Command used to set a new magnification values.	MEX>MAG!_2	MEX>MAG_2.000
			MEX>MAG!_2.5	MEX>MAG_2.500
			MEX>MAG!_2.547	MEX>MAG_2.547
MEX>MOF?	MEX>MOF_X.XXX	Command used to get current magnification adjustment coefficient (0 - means the lenses in the device is in their theoretical positions)	MEX>MOF?	MEX>MOF_0.3
MEX>MOF!_X.XXX	MEX>MOF_X.XXX	Command used to adjust magnification values: + to increase magnification - to decrease magnification (For. Ex. 1X magnification value (MAG_1) is chosen, but according to your laser beam parameters 1.09X actual magnification value is reached, so to calibrate magnification to required value MEX>MOF_-0.7 command must be sent)	MEX>MOF!_-0.7	MEX>MOF_-0.7

Command	Response	Comments	Example usage	
			User command	Device response
MEX>DOF?	MEX>DOF_X.XXX	Command used to get current divergence adjustment coefficient (0 - means the lenses in the device is in their theoretical positions)	MEX>DOF?	MEX>DOF_1.6
MEX>DOF!_X.XXX	MEX>DOF_X.XXX	Command used to collimate beam or get required divergence value: + to increase beam divergence - to decrease beam divergence (For. Ex. You can observe that laser beam beam is diverging too much and it must be collimated. To do that MEX>DOF_-0.5 or different values must be sent while observing the output)	MEX>DOF!_-0.5	MEX>DOF_-0.5
MEX>DOFR?	MEX>DOFR_X.XXX_Y.YYY	Command used to get allowed DOF values range. X.XXX – maximum DOF value Y.YYY – minimum DOF value	MEX>DOFR?	MEX>DOFR_8.257_-4.243
MEX>DOFC?	MEX>DOFC_X.XXX	Command used to get DOF value that is currently in use. In normal operation DOF and DOFC values match. In case of DOF boundary violation DOF value is overwritten with DOFC value which is within allowed DOF values range (DOFR).	MEX>DOFC?	MEX>DOFC_0.5
MEX>MOFR?	MEX>MOFR_X.XXX_Y.YYY	Command used to get allowed MOF values range. X.XXX – maximum MOF value. Y.YYY – minimum MOF value MOF range depends on DOF value.	MEX>MOFR?	MOFR_30.247_-4.014
MEX>MOFC?	MEX>MOFC_X.XXX	Command used to get MOF value that is currently in use. In normal operation MOF and MOFC values match. In case of MOF boundary violation MOF value is overwritten with MOFC value which is within allowed MOF values range.	MEX>MOFC?	MEX>MOFC_1.025
Settings Baud rate - BAUD, Wavelength - WL, Default - LDF				
MEX>BAUD?	MEX>BAUD_baud rate	Command used to get baud rate. (57600 by default)	MEX>BAUD?	MEX>BAUD_115200
MEX>BAUD!_baud rate	MEX>BAUD_baud rate	Command used to set baud rate. Up to 921600 bps.	MEX>BAUD!_57600	MEX>BAUD_57600
MEX>LDF!	MEX>LDF_X	Loads default speed, PID, Delta, and BaudRate values. X=0 – OK X=1 – Error X=2 – Busy X=3 – Timeout	MEX>LDF!	MEX>LDF_0

Command	Response	Comments	Example usage	
			User command	Device response
MEX>CWL?	MEX>CWL_XXX.X	Command to get the current working wavelength in nanometers.	MEX>CWL?	MEX>CWL_532.0
MEX>CWL!_XXX.X	MEX>CWL_XXX.X	Command to set the current working wavelength in nanometers. The device will change its current working wavelength only if it matches one of the design wavelengths! Design wavelengths can be seen by issuing an MEX>INFO? Command.	MEX>CWL!_1064	MEX>CWL_1064.0
			MEX>CWL!_999	MEX>CWL_1064.0
			MEX>CWL!_532.1	MEX>CWL_532.0
Information Device state - STATUS, information - INFO, Serial number - ID				
MEX>STATUS?	MEX>_X	Command used to get the current state of the device. X value is 32bit integer where each bit represents certain device state. Bits high (1) value meaning: Bit0 – motors in motion. Bit1 – motors are being stabilised. Bit2 – calculation warning. Bit3 – DOF violates allowed DOFR range. Bit4 – MOF violates allowed MOFR range. Bit5 – targets calculations OFF. Bit6 – motors OFF. Bit7 – spacing between lenses violation Bit8 – minimum position boundary violation Bit9 – maximum position boundary violation. Bit10 – motor1 is stuck. Bit11 – motor2 is stuck. Bit12 – encoder consistency error. Bit13 – device settings CRC error. Bit14 – calculation coefficients CRC error. Bit15 – encoder1 communication error. Bit16 – encoder2 communication error. Bit17 – encoder internal error. Bit18 – spacing between lenses calculation error. Bit19 – minimum position calculation error. Bit20 – maximum position calculation	MEX>STATUS?	MEX>_3
			MEX>STATUS?	MEX>_96
			MEX>STATUS?	MEX>1835104
MEX>INFO?	MEX>MMG_X.XXX_Y.YYY _CWL_QQQQ_WL_ZZZZ_U UUU_NNNN_MMM	Command used to get the current configuration of the device. X.XXX – maximum magnification value Y.YYY – minimum magnification value QQQQ – wavelength in use. ZZZZ – wavelength option. UUUU – wavelength option. NNNN – wavelength option. MMMM – wavelength option	MEX>INFO?	MEX>MMG_8.000_1.000 _CWL_532_WL_1064_53 2_0_0
MEX>ID?	MEX>_3BXXXXXXXX	Command used to get serial number.	MEX>ID?	MEX>_3B19040075

Command	Response	Comments	Example usage	
			User command	Device response
MEX>FW?	MEX>VER_X.X	Command used to get device firmware version	MEX>FW?	MEX>VER_1.1
Other Echo, Reset, Motor ON/OFF, Manual mode				
MEX>ECHO!	MEX>ECHO	Command used for troubleshooting. The device echoes the command sent to it before sending the response.	MEX>ECHO! MEX>MAG?	MEX>ECHO MEX>MAG? MEX>MAG_2
MEX>NOECHO!	MEX>NOECHO	Command used to disable ECHO command.		
MEX>RESTART!	MEX>RESTART	After 500 ms restarts device.	MEX>RESTART!	MEX>RESTART
MEX>ON!	MEX>ON	Command used to enable optical element actuation.	MEX>ON!	MEX>ON
MEX>OFF!	MEX>OFF	Command used to disable optical element actuation	MEX>OFF!	MEX>OFF
MEX>MANUAL!	MEX>MANUAL	Enables manual control of lenses positions. Used with “MEX>TGT1!” and “MEX>TGT2” commands.	MEX>MANUAL!	MEX>MANUAL
MEX>AUTO!	MEX>AUTO	Enables calculations of lenses positions. Used with “MEX>MAG!_X” and “MEX>DOF!_Y” commands.	MEX>AUTO!	MEX>AUTO

7.3. Serial communication example in Python

```
import serial
import serial.tools.list_ports

def serial_ports():
    ports = serial.tools.list_ports.comports()
    return [port.name for port in ports]

if __name__ == "__main__":
    ports = serial_ports()
    print("Select port number ( starting from 0, 1, 2 etc.):")
    print(ports)
    port = ports[int(input())]
    print(port)

    # configure the serial connections
    ser = serial.Serial(
        port=port,
        baudrate=115200,
        parity=serial.PARITY_ODD,
        stopbits=serial.STOPBITS_TWO,
        bytesize=serial.EIGHTBITS,
        timeout=1 #second
    )
    ser.isOpen()

    print('Enter your commands below.\r\nInsert "exit" to leave the application.')
    cmd=1
    while 1 :
        cmd = input(">> ") # get keyboard input
        if cmd == 'exit':
            ser.close()
            break
        else:
            # send the string to the device
            # (note that \n or \r append is required - this is requested by device)
            cmdBytes = (cmd + '\n').encode()
            ser.write(cmdBytes)
            out = ''
            out = str(ser.readline())
            if out != '':
                print(">>" + out)
```

9. Technical drawings

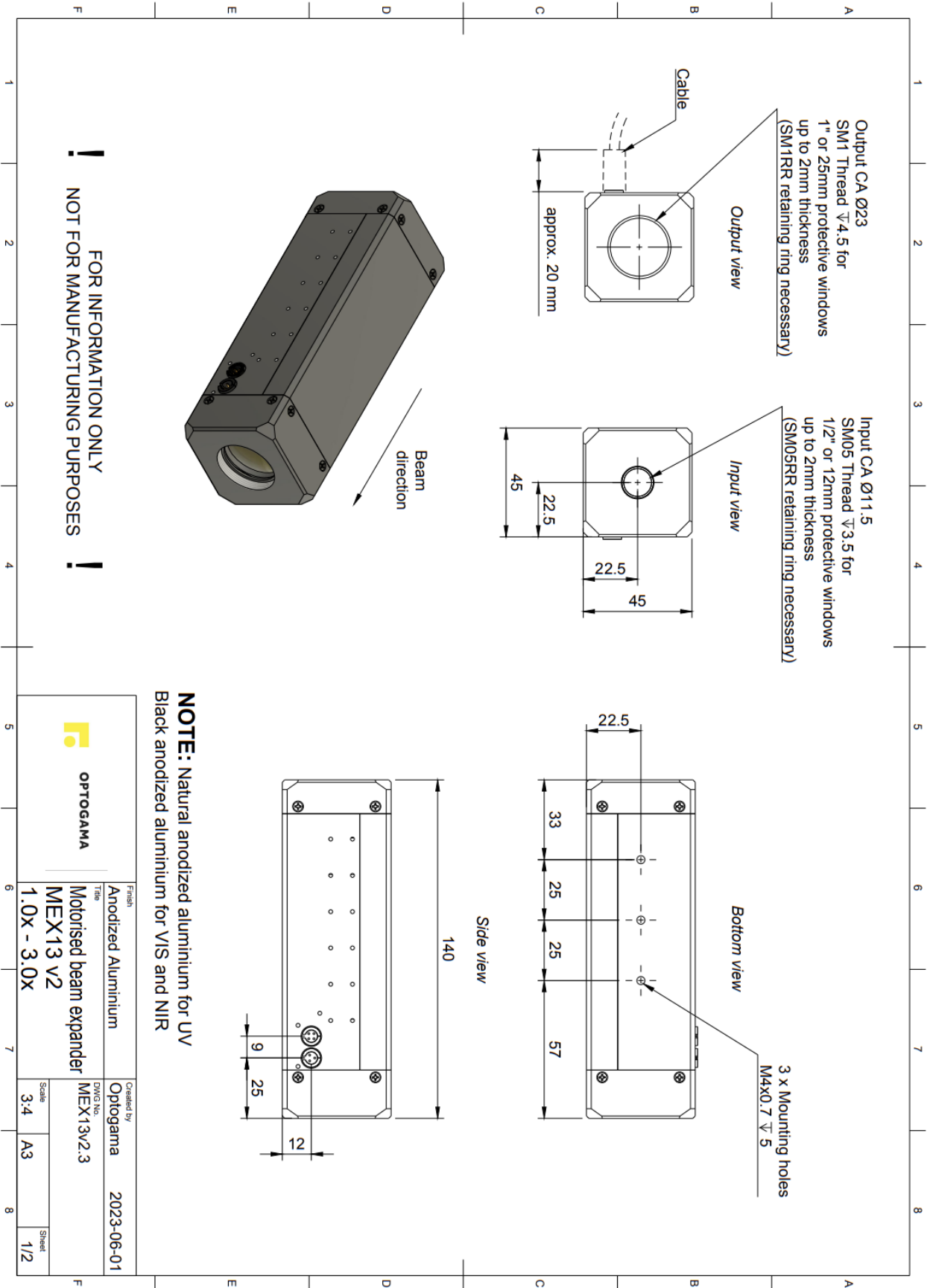

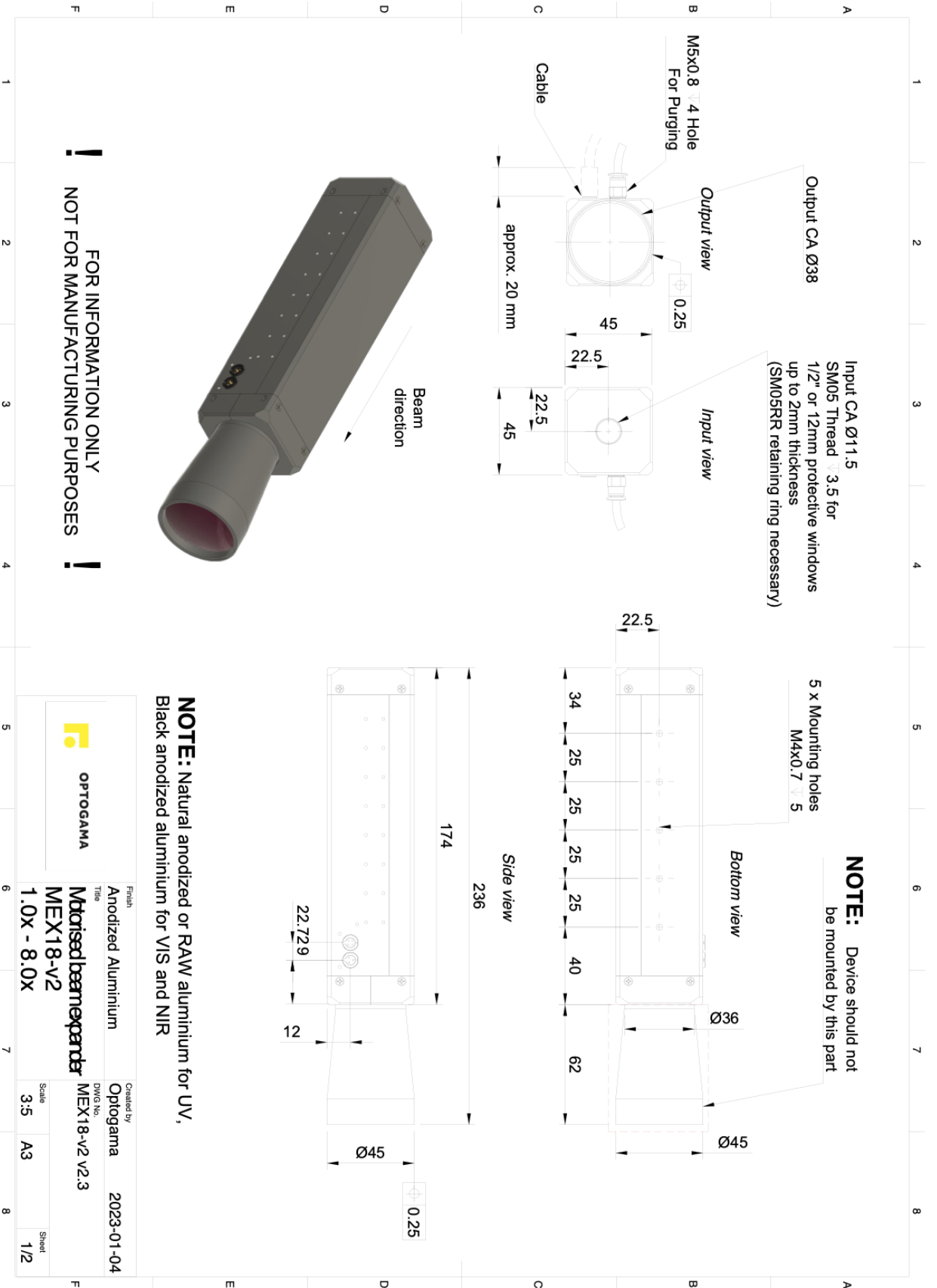

FOR INFORMATION ONLY
NOT FOR MANUFACTURING PURPOSES

		Created by Optogama		2023-01-04	
Finish Anodized Aluminium		DWG No. MEX18-v2.2.3		Title MEX18-v2	
Title MEX18-v2		Scale 3:5		Sheet A3	
1.0x - 8.0x		1/2			

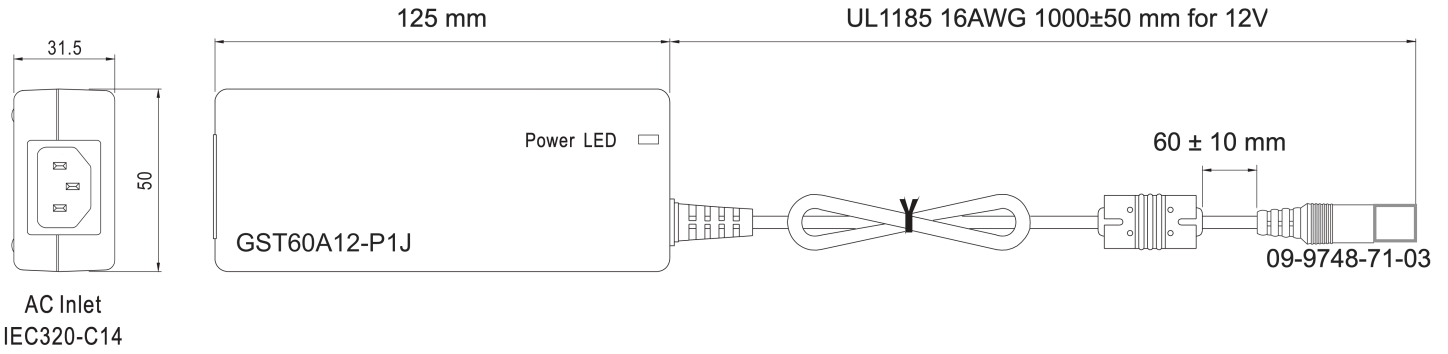
Technical data

Brand	Mean Well
Item number	GST60A12-P1J
Series	GST60A
Description	AC-DC Industrial desktop adaptor; Output 12Vdc at 5A; 3 pole AC inlet IEC320-C14
Application	ITE EN/UL/IEC 60950
Technology	AC/DC
Power Format	Desktop
Output Power (W)	60
Output Voltage (V)	12
Output Current (A)	5
Input Voltage (V)	90 - 264 Universal Input 110/230V
IP Rating	No IP assigned
Width (mm)	50
Height (mm)	31.5
Depth (mm)	125

OPTOGAMA, UAB
Mokslininku str. 6B,
LT-08412, Vilnius, Lithuania
+37052194884
sales@optogama.com
www.optogama.com



OPTOGAMA